

**COMPONENTES  
PARA ARADO**  
PIÈCES D'USURE CHARRUE  
PLOUGH PARTS

**2021**

CATÁLOGO · CATALOGUE · CATALOGUE



**campoagrícola**

Fabricación y distribución de repuesto agrícola  
Fabrication et distribution de pièces de rechange agricoles  
Manufacture and distribution of agricultural spare parts

# COMPONENTES PARA ARADO ADAPTABLE A GIL

PIÈCES D'USURE ADAPTABLES GIL / WEARING PARTS TO FIT GIL

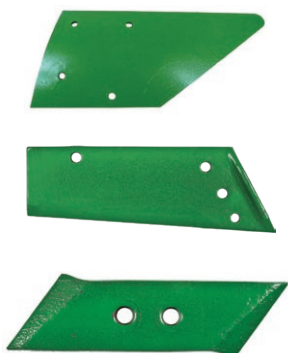

NUEVO

VERTEDERA							
Cód. num.	Modelo B	KG	📦	↑	→	≡	
1216301	1886-D	5,40	100	221	523	8	

REJA							
Cód. num.	Modelo B	KG	📦	↑	→	≡	
1216400	1439-D	2,75	100	125	360	9	

PUNTERA							
Cód. num.	Modelo B	KG	📦	↑	→	≡	
1216500	1435-D	1,05	100	60	250	8	
1216600	1435-I	1,05	100	60	250	8	

# COMPONENTES PARA ARADO ADAPTABLE A GREGOIRE BESSON

PIÈCES D'USURE ADAPTABLES GREGORIE BESSON / COMPONENTS FOR ADAPTABLE PLOUGHING TO FIT GREGORIE BESSON



PUNTERA							
Cód. num.	Modelo B	KG	📦	↑	→	≡	
1216900	173332-D	2,07	100	75	305	15	
1217000	173331-I	2,07	100	75	305	15	
1217100	177328-D	2,07	100	75	305	15	
1217200	177327-I	2,07	100	75	305	15	

REJA							
Cód. num.	Modelo B	KG	📦	↑	→	≡	
1217300	177602-D	6,7	100	145	652	14	
1217400	177601-I	6,7	100	145	652	14	
1217500	178126-D	6,7	100	140	650	14	
1217600	178125-I	6,7	100	140	650	14	

# COMPONENTES ADAPTABLES A HORSCH TERRANO

PIÈCES D'USURE ADAPTABLES HORSCH / WEARING PARTS TO FIT HORSCH



NUEVO



NUEVO



NUEVO



NUEVO

PUNTA								
Cód. num.	O.E.M.	Modelo B	KG	📦	↑	→	≡	
1217610	34060850	15055-A80	1,80	100	120	230	10	

ALETA								
Cód. num.	O.E.M.	Modelo B	KG	📦	↑	→	≡	
1217611	34060856	15056-A-Izda.	1,9	100	-	195	10	
1217612	34060857	15056-A-dcha.	1,9	100	-	195	10	

DEFLECTOR LARGO								
Cód. num.	O.E.M.	Modelo B	KG	📦	↑	→	≡	
1217615	34060859	15057-A-80-D-HRS	1,9	100	80	420	8	
1217616	34060858	15057-A-80-I-HRS	1,9	100	80	420	8	

  



DEFLECTOR CORTO								
Cód. num.	O.E.M.	Modelo B	KG	📦	↑	→	≡	
1217613	34060863	15058-A-80-D-HRS	1,2	100	80	270	8	
1217614	34060862	15058-A-80-I-HRS	1,2	100	80	270	8	
1217619	Modelo especial Campoagrícola dcha.							
1217620	Modelo especial Campoagrícola izda.							

# COMPONENTES PARA ARADO ADAPTABLE A KVERNELAND

PIÈCES D'USURE ADAPTABLES KVERNELAND / COMPONENTS FOR ADAPTABLE PLOUGHING TO FIT KEVERNELAND

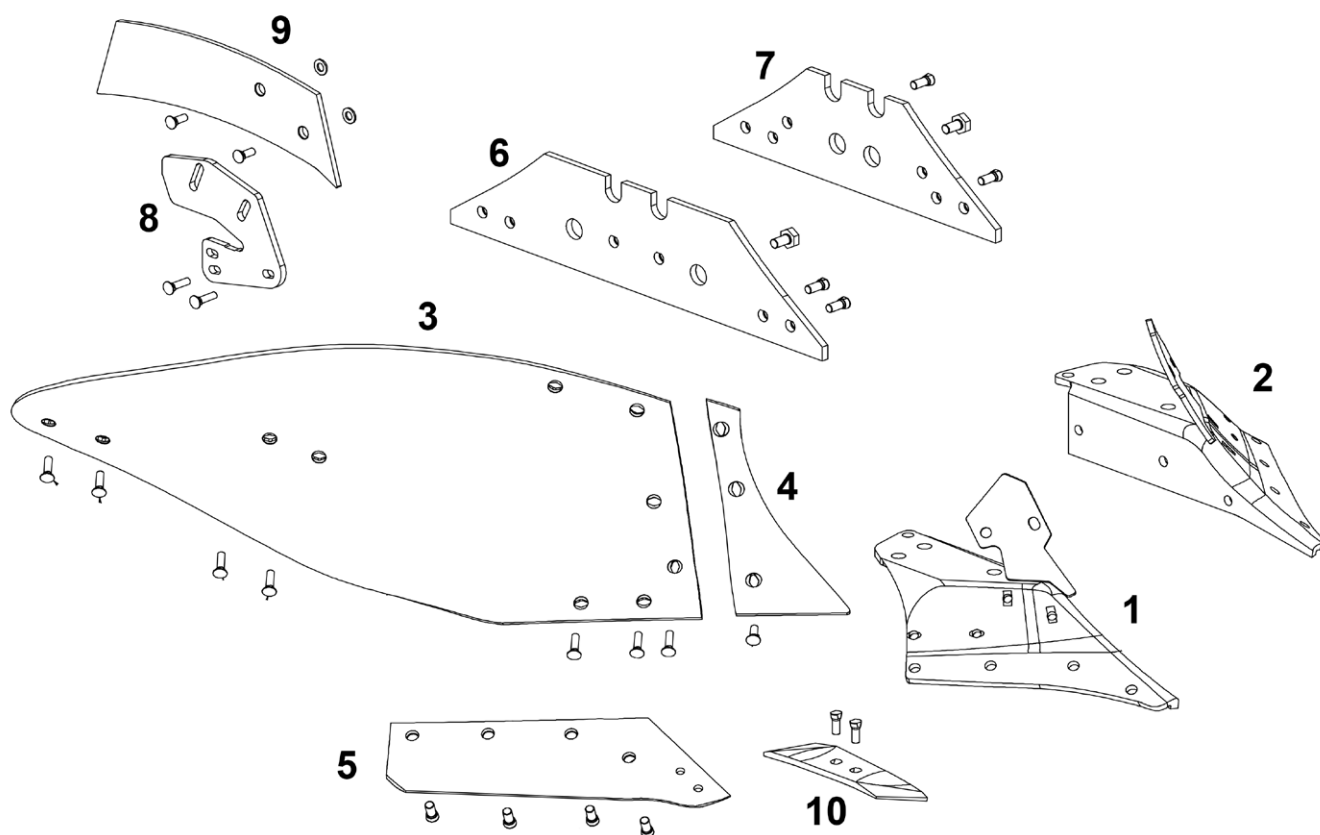
## ADAPTABLE A KVERNELAND



Nº	Descripción	O.E.M.		
1	Cuerpo soporte N°9	73411		
2	Cuerpo soporte N°9	73412		
3	Vertedera	073286 - 073287 - 073290 - 073291	M. 12 x 1,75 x 35 (2 prisioneros)	10.9
4	Complemento	073230 - 073231 - 073250 - 073251 - 073256 - 073257	M. 12 x 1,75 x 30 (2 prisioneros)	10.9
5	Reja	073004 - 073005 - 073006 - 073007 - 073056 - 073057 - 073080 - 073081	M. 14 x 2,00 x 34 (cónico)	12.9
6	Costanera larga	73609	M. 14 x 2,00 x 45 (cónico)	12.9
7	Costanera corta	73608	M. 14 x 2,00 x 45 (cónico)	12.9
8	Soporte cubre rastros	073310 - 073311	M. 12 x 1,75 x 35 (2 prisioneros)	10.9
9	Cubre rastros	073300 - 073301	M. 12 x 1,75 x 35 (2 prisioneros)	10.9
10	Puntera	053090 - 063090	M. 12 x 1,75 x 38 (cónico)	12.9

# COMPONENTES PARA ARADO ADAPTABLE A KVERNELAND

## PIÈCES D'USURE ADAPTABLES KVERNELAND / COMPONENTS FOR ADAPTABLE PLOUGHING TO FIT KEVERNELAND



VERTEDERA							
Cód. num.	O.E.M.	Modelo B	KG	Embalaje	↑	→	Espesor
1200401	73286	N° 8 1797-D	20,9	25	477	1.059	8
1200101	73287	N° 8 1797-I	20,9	25	477	1.059	8
1200300	73290	N° 9 1834-D	20,7	25	440	980	8
1200400	73291	N° 9 1834-I	20,7	25	440	980	8



COMPLEMENTOS							
Cód. num.	O.E.M.	Modelo B	KG	Embalaje	↑	→	Espesor
1200500	73230	N° 19 1849-D	1,8	100	325	160	8
1200600	73231	N° 19 1849-I	1,8	100	325	160	8
1200700	73250	N° 7-8 1798-D	1,5	100	278	162	8
1200800	73251	N° 7-8 1798-I	1,5	100	278	162	8
1200900	73256	N° 9-1835-D	1,6	100	325	166	8
1201000	73257	N° 9-1835-I	1,6	100	325	166	8



NUEVO

PUNTERA							
Cód. num.	O.E.M.	Modelo B	KG	Embalaje	↑	→	Espesor
1202100	53090	1365-D	1,3	500	65	260	12
1202200	63090	1365-I	1,3	500	65	260	12
1202300	053090-15	1365-D-15	1,6	500	65	260	15
1202400	063090-15	1365-I-15	1,6	500	65	260	15
1202500	053090-CN	-	1,4	500	65	260	13
1202600	063090-CN	-	1,4	500	65	260	13



REJA							
Cód. num.	O.E.M.	Modelo B	KG	Embalaje	↑	→	Espesor
1201200	73004	1374 16-D	5,5	200	142	370	12
1201400	73005	1374 16-I	5,5	200	142	370	12
1201500	73006	1374 18-D	6,4	200	142	450	12
1201600	73007	1374 18-I	6,4	200	142	450	12
1201700	73056	1434 16-D	5,8	200	144	380	13
1201800	73057	1434 16-I	5,8	200	144	380	13
1201900	73080	1434 18-D	6,3	200	144	465	13
1202000	73081	1434 18-I	6,3	200	144	465	13



CUERPO SOPORTE N° 9			
Cód. num.	O.E.M.	KG	Embalaje
1202700	073411-D	13,2	15
1202800	073412-I	13,2	15

# COMPONENTES PARA ARADO ADAPTABLE A KVERNELAND

PIÈCES D'USURE ADAPTABLES KVERNELAND / COMPONENTS FOR ADAPTABLE PLOUGHING TO FIT KEVERNELAND



COSTANERA							
Cód. num.	O.E.M.	Modelo B	KG	Embalaje	↑	→	≡
1202900	73608	2327	5,25	100	170	566	12
1203000	73609	2328	7,9	100	170	746	12

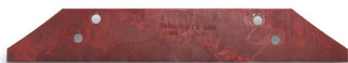

REFUERZO DE COSTANERA							
Cód. num.	Modelo B	KG	Embalaje	↑	→	≡	
1203100	2327 PROTECT	4,2	100	90	566	12	
1203200	2328 PROTECT	5,75	100	90	746	12	



SOPORTE CUBRERASTROJOS							
Cód. num.	O.E.M.	Modelo B	KG	Embalaje	↑	→	≡
1203300	73310	1860-D	2,15	250	200	220	10
1203400	73311	1860-I	2,15	250	200	220	10



CUBRERASTROJOS							
Cód. num.	O.E.M.	Modelo B	KG	Embalaje	↑	→	≡
1203500	73300	1857-D	3,29	250	160	460	8
1203600	73301	1857-I	3,29	250	160	460	8

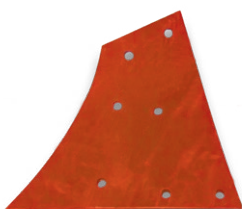

BOCATEJA							
Cód. num.	O.E.M.	KG	Embalaje	↑	→	≡	
1203700	1835-D-PRO	4,5	250	365	387	7	
1203800	1835-I-PRO	4,5	250	365	387	7	
1200100	1798-D-PRO	3,6	250	374	325	7	
1200200	1798-I-PRO	3,6	250	374	325	7	

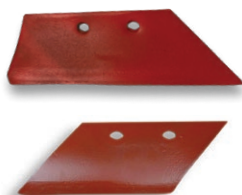

REJA DE RASETA							
Cód. num.	O.E.M.	Modelo B	KG	Embalaje	↑	→	≡
1204100	66868	1394-D	1,55	200	100	330	8
1204200	66869	1394-I	1,55	200	100	330	8
1204403	56873	1386-D	1,05	200	100	190	8
1204404	66873	1386-I	1,05	200	100	190	8



VERTEDERA DE RASETA							
Cód. num.	O.E.M.	Modelo B	KG	Embalaje	↑	→	≡
1204300	66878	1818-D	1,4	50	175	360	4
1204400	66879	1818-I	1,4	50	175	360	4
1204401	66880	1819-D	1,35	50	155	360	4
1204402	66881	1819-I	1,35	50	155	360	4

# COMPONENTES PARA ARADO ADAPTABLE A KUHN/HUARD

PIÈCES D'USURE ADAPTABLES KUHN/HUARD / COMPONENTS FOR ADAPTABLE PLOUGHING TO FIT KUHN/HUARD

## ADAPTABLE A KUHN/HUARD

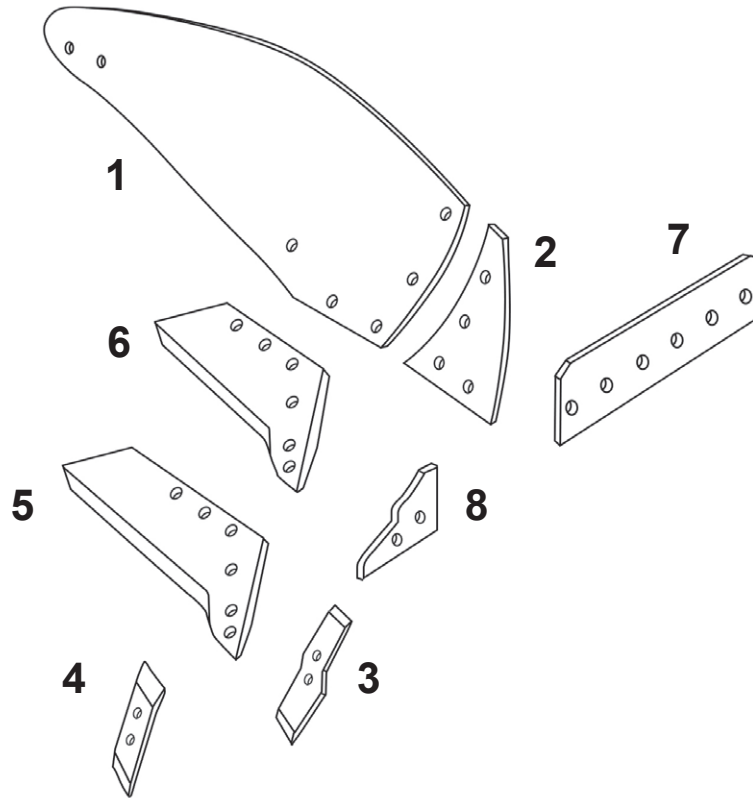

Nº	Descripción	O.E.M.	🔩	☑
1	Vertedera	616138 - 616139 - 612108 - 612109	M. 12 x 1,75 x 30 (2 prisioneros)	8.8
			M. 12 x 1,75 x 35 (2 prisioneros)	8.8
2	Complemento	619172 - 619173	M. 12 x 1,75 x 35 (2 prisioneros)	10.9
3	Punta Marathon	622128 - 622129	M. 12 x 1,75 x 34 (cónico)	12.9
4	Puntera	622180 - 622181	M. 12 x 1,75 x 34 (cónico)	12.9
5	Reja 14"	622134 - 622135 - 622140 - 622141 - 622166 - 622167	M. 14 x 2,00 x 35 (2 prisioneros)	8.8
6	Reja 16"	622212 - 622213 - 622136 622137 - 622142 - 622143 622172 - 622173	M. 14 x 2,00 x 35 (2 prisioneros)	8.8
7	Costanera	279140	M. 12 x 1,75 x 34 (cónico)	12.9
8	Punta de costanera	279138 - 279139	M. 12 x 1,75 x 34 (cónico)	12.9



PUNTERA							
Cód. num.	O.E.M.	Modelo B	📊	📦	↑	→	☰
1204500	622128	1385-D	1,85	250	85	300	12
1204600	622129	1385-I	1,85	250	85	300	12
1204700	622180	1388-D	1,85	250	85	300	12
1204800	622181	1388-I	1,85	250	85	300	12

# COMPONENTES PARA ARADO ADAPTABLE A KUHN/HUARD

PIÈCES D'USURE ADAPTABLES KUHN/HUARD / COMPONENTS FOR ADAPTABLE PLOUGHING TO FIT KUHN/HUARD



REJA							
Cód. num.	O.E.M.	Modelo B	kg		↑	→	≡
1204601	622212	1383-16-LD	6,2	200	158	671	12
1204602	622213	1383-16-LI	6,2	200	158	671	12
1204900	622134	1383 14-D	5,3	200	158	587	12
1205000	622135	1383 14-I	5,3	200	158	587	12
1205100	622136	1383 16-D	6	200	258	671	12
1205200	622137	1383 16-I	6	200	258	671	12
1205300	622140	1384 14-D	5,5	150	158	587	12
1205400	622141	1384 14-I	5,5	150	158	587	12
1205500	622142	1384 16-D	6,2	150	158	671	12
1205600	622143	1384 16-I	6,2	150	158	671	12
1205700	622166	1430 14-D	5,3	150	173	570	10
1205800	622167	1430 14-I	5,3	150	173	570	10
1205900	622172	1430 16-D	5,7	150	173	654	10
1206000	622173	1430 16-I	5,7	150	173	654	10



COMPLEMENTOS							
Cód. num.	O.E.M.	kg		↑	→	≡	≡
1206100	619172	2,5	150	160	139	8	
1206200	619173	2,5	150	160	139	8	

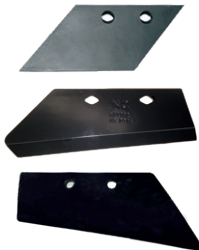

REJA DE RASETA							
Cód. num.	O.E.M.	Modelo B	kg		↑	→	≡
1206300	631100	1433 D	1,4	50	107	270	10
1206310	631101	1433 I	1,4	50	107	270	10
1206500	631102	1372 D	1,3	50	97	280	8
1206600	631103	1372 I	1,3	50	97	280	8
1206700	631108	-	1,56	50	107	275	10
1206800	631109	-	1,56	50	107	275	10



COSTANERA							
Cód. num.	O.E.M.	Modelo B	kg		↑	→	≡
1207200	279140	2329 C	5,5	50	130	550	10
1207203	279138	2346-D	0,9	50	76	155	10
1207204	279139	2346-I	0,9	50	76	155	10

# COMPONENTES PARA ARADO ADAPTABLE A LANAU

PIÈCES D'USURE ADAPTABLES LANAU / COMPONENTS FOR ADAPTABLE PLOUGHING TO FIT LANAU





REJA							
Cód. num.	O.E.M.	Modelo B	kg		↑	→	≡
1216700	1383-14 DCA	6	100	158	587	12	
1216800	1383-14 ICA	6	100	158	587	12	

# COMPONENTES PARA ARADO ADAPTABLE A LEMKEN

PIÈCES D'USURE ADAPTABLES LEMKEN / COMPONENTS FOR ADAPTABLE PLOUGHING TO FIT LEMKEN

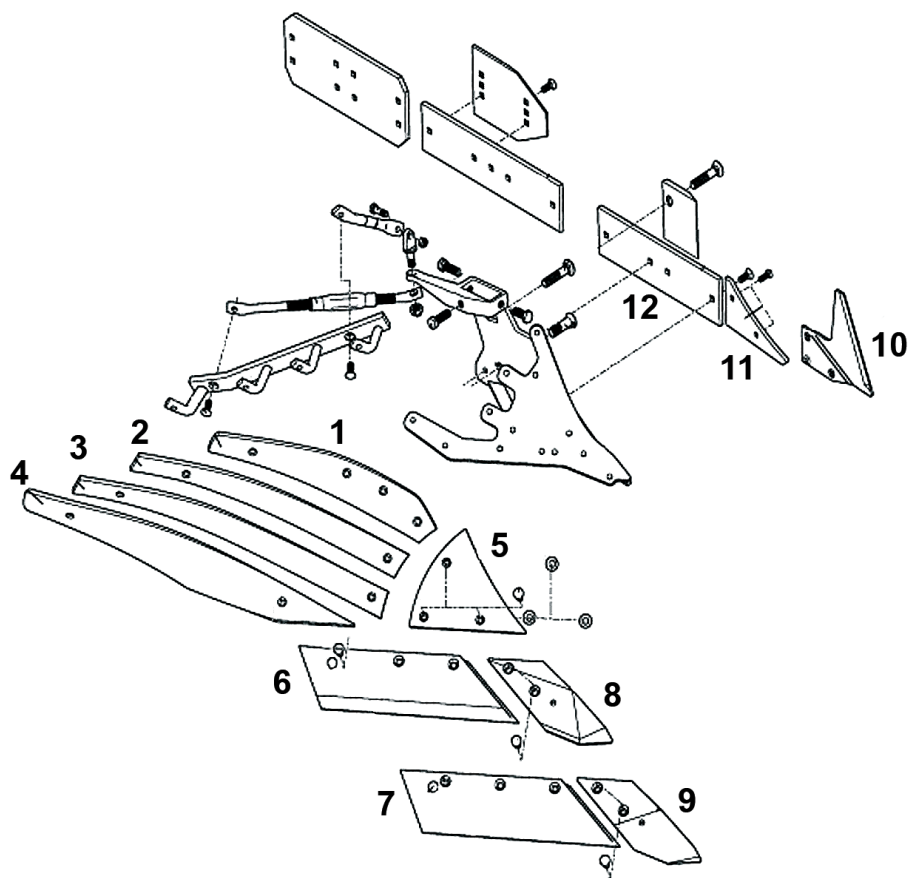
## ADAPTABLE A LEMKEN













Nº	Descripción	O.E.M.		
1	Lámina 1	3444010 - 3444011 - 3444110 - 3444111	M. 10 x 1,50 x 45 (608)	12.9
2	Lámina 2	3444020 - 3444021 - 3444120 - 3444121	M. 10 x 1,50 x 45 (608)	12.9
3	Lámina 3	3444030 - 3444031 - 3444130 - 3444131	M. 10 x 1,5 x 45 (608)	12.9
4	Lámina 4	3444042 - 3444043 - 3444140 - 3444141	M. 10 x 1,50 x 45 (608)	12.9
5	Complemento de vertedera	3451002 - 3451003 - 3451004 - 3451005	M. 10 x 1,50 x 33 (608)	12.9
6	Reja	3352030 - 3352031	M. 12 x 1,75 x 33 (608)	10.9
7	Reja	3352034 - 3352035	M. 12 x 1,75 x 33 (608)	10.9
8	Punta-reja Hard Face	3364150 - 3364151	M. 12 x 1,75 x 50 (608)	12.9
9	Punta	3364050 - 3364051	M. 12 x 1,75 x 50 (608)	12.9
10	Cuchilla de talonera	3492890 - 3492891	M. 10 x 1,50 x 45 (608)	12.9
11	Triángulo de talonera	3401900 - 3401901	M. 10 x 1,50 x 33 (608)	12.9
12	Talonera	3411504	M. 12 x 1,75 x 33 (608)	10.9

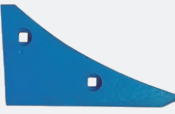

# COMPONENTES PARA ARADO ADAPTABLE A LEMKEN

PIÈCES D'USURE ADAPTABLES LEMKEN / COMPONENTS FOR ADAPTABLE PLOUGHING TO FIT LEMKEN



ARADO							
Modelo	Cód. num.	Descripción	O.E.M.	KG	↑	→	≡
	1208900 1209000	PUNTA-REJA HARDFACE	3364150 3364151	2,50	105	350	19
	1209100 1209200	PUNTA-REJA	3364050 3364051	2,00	105	350	19
	1209300 1209400	PUNTA REVERSIBLE	3365540 3365541	2,00	100	370	12
	1209500 1209600	REJA 2 AGUJEROS	3352030 3352031	4,00	150	500	10
	1209700 1209800	REJA 3 AGUJEROS	3352034 3352035	4,50	150	570	10
	1209900	REJA DE RASETA REVERSIBLE	3363724	1,60	105	365	10
	1211600 1211700 1211800 1211900	COMPLEMENTO DE VERTEDERA	3451002 3451003 3451004 3451005	3,50 2,20	235	240	10
	1212000 1212100	VERTEDERA DE RASETA	3470600 3470601	6,00	-	-	10
	1212200 1212300	CUCHILLA DE TALONERA	3492890 3492891	1,55	240	240	10
	1212400 1212500	TRIÁNGULO DE TALONERA	3401900 3401901	1,00	120	190	10
	1212600	TALONERA	3411504	4,70	120	420	10

# COMPONENTES ADAPTABLES A LEMKEN SMARAGD

PIÈCES D'USURE ADAPTABLES LEMKEN SMARAGD / COMPONENTS FOR ADAPTABLE PLOUGHING TO FIT LEMKEN SMARAGD

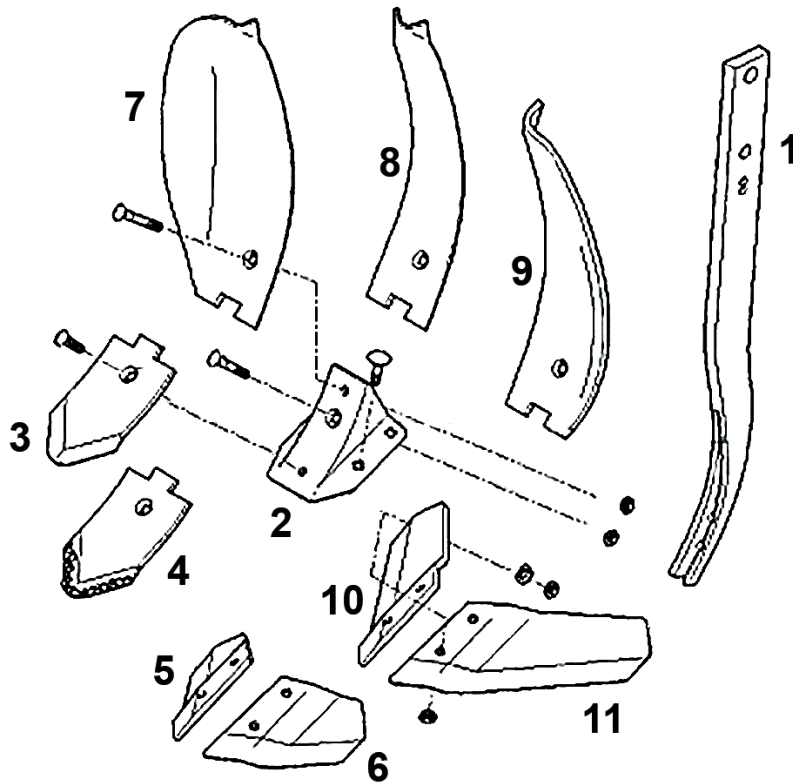
## ADAPTABLE A LEMKEN SMARAGD



N°	Descripción	O.E.M.	 Tipo de tornillo / Type à vis / Screw type	 Calidad / Quality / Qualité
1	Brazo forjado Lemken Smaragd	4653680	M. 24 M20 2,00 x M12 (603)	
2	Soporte Central	4679105	M. 12 x 1,75 x 35 (603)	10.9
3	Punta	3374388	M. 12 x 1,75 x 35 (608)	10.9
4	Punta Hard Faced	3374392	M. 12 x 1,75 x 35 (608)	10.9
5	Aleta quebrada derecha	3374418	M. 12 x 1,75 x 30 (608)	10.9
6	Aleta quebrada Izquierda	3374419	M. 12 x 1,75 x 30 (608)	10.9
7	Deflector derecho	3374398	M. 12 x 1,75 x 65 (608)	12.9
8	Deflector central	3374395	M. 12 x 1,75 x 65 (608)	12.9
9	Deflector izquierdo	3374399	M. 12 x 1,75 x 65 (608)	12.9
10	Aleta derecha	3374416	M. 12 x 1,75 x 30 (608)	10.9
11	Aleta Izquierda	3374417	M. 12 x 1,75 x 30 (608)	10.9

# COMPONENTES ADAPTABLES A LEMKEN SMARAGD

PIÈCES D'USURE ADAPTABLES LEMKEN SMARAGD / COMPONENTS FOR ADAPTABLE PLOUGHING TO FIT LEMKEN SMARAGD



LEMKEN SMARAGD								
Modelo	Cód. num.	Descripción	O.E.M.	Modelo B	kg	↑	→	≡
	1212700	Soporte central 195 X 150 x 10	4679105	1595 10 CA	2,35	195	150	10
	1212800	Aleta quebrada derecha 350 X 130 x 10	3374418	1516 10 D CA	2,10	350	130	10
	1212900	Aleta quebrada izquierda 350 X 130 x 10	3374419	1516 10 I CA	2,10	350	130	10
	1213000	Aleta quebrada Hard faced derecha 350 X 130 x 0	3374425	-	2,65	350	130	10
	1213100	Aleta quebrada Hard faced Izquierda 350 X 130 x 10	3374424	-	2,65	350	130	10
	1213200	Aleta derecha 350 X 130 x 10	3374416	1596 10 D CA	2,05	350	130	10
	1213300	Aleta izquierda 350 X 130 x 10	3374417	1596 10 I CA	2,05	350	130	10
	1213400	Punta 230 X 120 x 10	3374388	1515 10 CA	2,05	230	120	10
	1213500	Punta Hard faced 235 X 120 x 12	3374392	1515 12 CA AP2	2,20	230	120	12
	1213600	Deflector central 295 X 100 x 8	3374395	1597 A 8 CA	1,85	295	100	8
	1213700	Deflector derecho 300 X 110 x 8	3374398	1598 8 D CA	2,40	300	110	8
	1213800	Deflector Izquierdo 300 X 110 x 8	3374399	1598 8 I CA	2,40	300	110	8

# COMPONENTES ADAPTABLES A LEMKEN KRISTALL

PIÈCES D'USURE ADAPTABLES LEMKEN KRISTALL / COMPONENTS FOR ADAPTABLE PLOUGHING TO FIT LEMKEN KRISTA

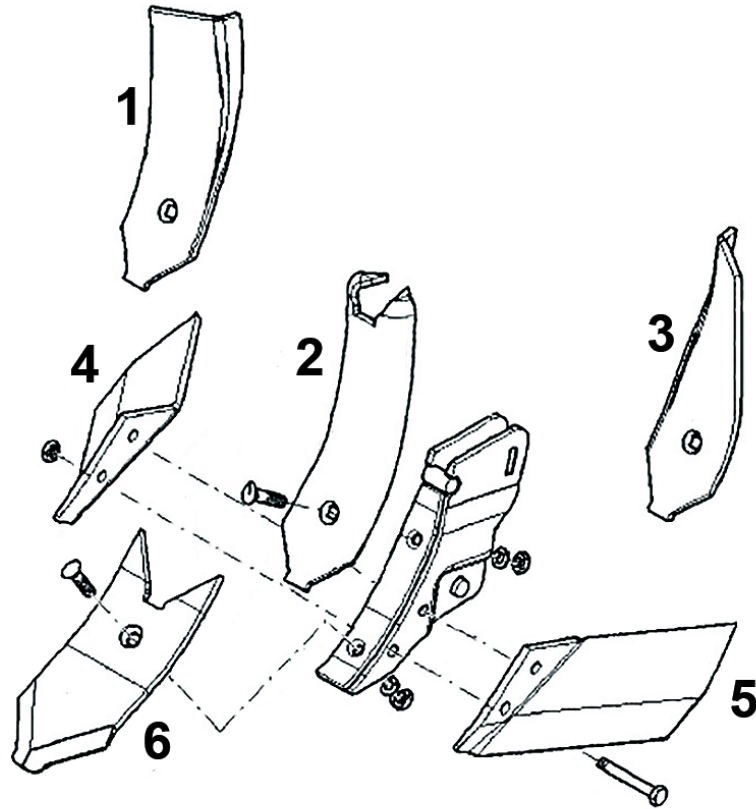
## ADAPTABLE A LEMKEN KRISTALL



N°	Descripción	O.E.M.		
1	Deflector derecho	3374490	M. 12 x 1,75 x 75 (608)	12.9
2	Deflector central	3374484	M. 12 x 1,75 x 75 (608)	12.9
3	Deflector izquierdo	3374491	M. 12 x 1,75 x 75 (608)	12.9
4	Aleta derecha	3374530 - 3374536 - 3374540	M. 12 x 1,75 x 70 (608)	12.9
5	Aleta izquierda	3374531 - 3374537 - 3374541	M. 12 x 1,75 x 70 (608)	12.9
6	Punta	3374443	M. 12 x 1,75 x 50 (608)	12.9



Tipo de tornillo / Type à vis / Screw type



Calidad / Quality / Qualité

# COMPONENTES ADAPTABLES A LEMKEN KRISTALL

PIÈCES D'USURE ADAPTABLES LEMKEN KRISTALL / COMPONENTS FOR ADAPTABLE PLOUGHING TO FIT LEMKEN KRISTA

LEMKEN KRISTALL							
Modelo	Cód. num.	Descripción	O.E.M.	KG	↑	→	≡
	1214400	Deflector derecho	3374490	1,9	320	100	8
	1214500	Deflector izquierdo	3374491	1,9	320	100	8
	1215000	Deflector central	3374484	2	335	100	8
	1215100	Aleta derecha 340	3374530	2,96	-	340	10
	1215200	Aleta izquierda 340	3374531	2,96	-	340	10
	1215300	Aleta derecha 370	3374536	3,26	-	370	10
	1215400	Aleta izquierda 370	3374537	3,26	-	370	10
	1215500	Aleta derecha 400	3374540	3,51	-	400	10
	1215600	Aleta izquierda 400	3374541	3,51	-	400	10
	1215700	Punta	3374442	2,5	285	120	12

# COMPONENTES ADAPTABLES A LEMKEN KARAT

PIÈCES D'USURE ADAPTABLES LEMKEN KARAT / COMPONENTS FOR ADAPTABLE PLOUGHING TO FIT KARAT



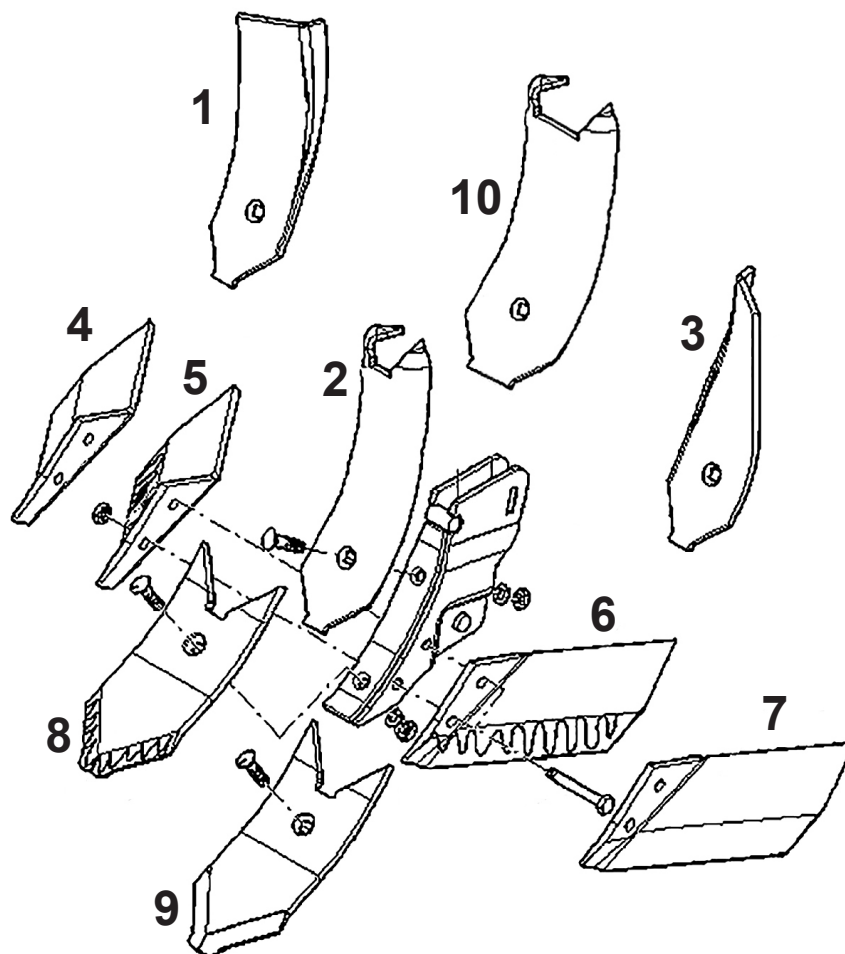













## ADAPTABLE A LEMKEN KARAT



N°	Descripción	O.E.M.		
1	Deflector derecho	3374490	M. 12 x 1,75 x 75 (608)	12.9
2	Deflector central	3374482	M. 12 x 1,75 x 75 (608)	12.9
3	Deflector izquierdo	3374491	M. 12 x 1,75 x 75 (608)	12.9
4	Aleta derecha	3374460	M. 12 x 1,75 x 70 (608)	12.9
5	Aleta derecha Hard Face	3374462	M. 12 x 1,75 x 70 (608)	12.9
6	Aleta izquierda Hard Face	3374463	M. 12 x 1,75 x 70 (608)	12.9
7	Aleta izquierda	3374461	M. 12 x 1,75 x 70 (608)	12.9
8	Punta Hard Face	3374443	M. 12 x 1,75 x 50 (608)	12.9
9	Punta standard	3374442	M. 12 x 1,75 x 50 (608)	12.9
10	Deflector central ancho	3374484	M. 12 x 1,75 x 75 (608)	12.9

# COMPONENTES ADAPTABLES A LEMKEN KARAT

PIÈCES D'USURE ADAPTABLES LEMKEN KARAT / COMPONENTS FOR ADAPTABLE PLOUGHING TO FIT KARAT

LEMKEN KARAT							
Modelo	Cód. num.	Descripción	O.E.M.	 KG			
	1214000	Punta 280 x 120 x 10	3374442	2	280	120	10
	1214100	Punta hard faced 280 x 120 x 12	3374443	2,4	280	120	12
	1214200	Punta hard faced 260 x 80 x 15	3374441	2,6	260	80	15
	1214201	Punta 260 x 80 x 15	-	2,6	260	80	15
	1214300	Deflector central 335 x 80 x 8	3374482	1,6	335	80	8
	1214400	Deflector derecho 320 x 100 x 8	3374490	1,9	330	100	8
	1214500	Deflector izquierdo 320 x 100 x 8	3374491	1,9	330	100	8
	1214600	Aleta derecha 341 x 130 x 10	3374460	2,6	341	130	10
	1214700	Aleta izquierda 341 x 130 x 10	3374461	2,6	341	130	10
	1214800	Aleta hard faced derecha 341 x 130 x 10	3374462	2,8	341	130	10
	1214900	Aleta hard faced izquierda 341 x 130 x 10	3374463	2,8	341	130	10
	1215000	Deflector central ancho 335 x 100 x 8	3374484	2	335	100	8

# COMPONENTES PARA ARADO ADAPTABLE A ÖVERUM

PIÈCES D'USURE ADAPTABLES ÖVERUM / COMPONENTS FOR ADAPTABLE PLOUGHING TO FIT ÖVERUM



NUEVO

## VERTEDERA

Cód. num.	O.E.M.	Modelo B	KG				
1217601	94594	1848-D	19,5	25	421	1022	8
1217602	94595	1848-I	19,5	25	421	1022	8



NUEVO

## REJA

Cód. num.	O.E.M.	Modelo B	KG				
1217603	94600	1446-16-D	3,6	50	150	467	11
1217604	94601	1446-16-I	3,6	50	150	467	11



NUEVO

## PUNTERA

Cód. num.	O.E.M.	Modelo B	KG				
1217605	94608	1442-D	1,8	100	100	315	12
1217606	94609	1442-I	1,8	100	100	315	12



NUEVO

## COSTANERA

Cód. num.	O.E.M.	Modelo B	KG				
1217607	063600A	2319	1,4	100	70	240	12

# COMPONENTES PARA ARADO ADAPTABLE A VOGEL & NOOT

PIÈCES D'USURE ADAPTABLES VOGEL & NOOT / COMPONENTS FOR ADAPTABLE PLOUGHING TO FIT VOGEL & NOOT

## ADAPTABLE A VOGEL & NOOT

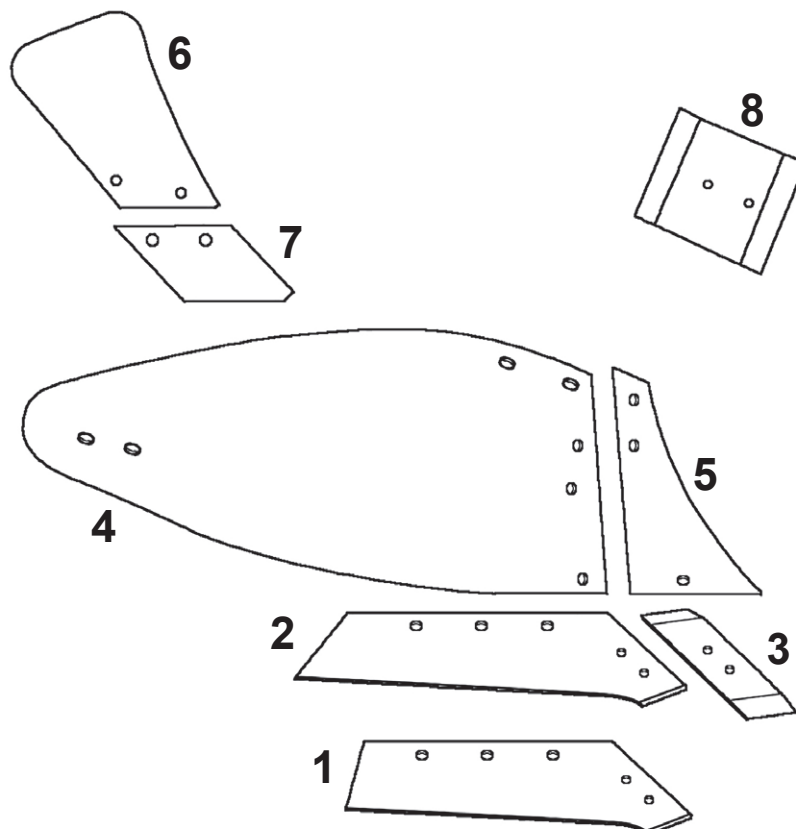



# COMPONENTES PARA ARADO ADAPTABLE A VOGEL & NOOT

PIÈCES D'USURE ADAPTABLES VOGEL & NOOT / COMPONENTS FOR ADAPTABLE PLOUGHING TO FIT VOGEL & NOOT

N°	Descripción	O.E.M.		
1	Reja	WSM43 PK8.013.01 WSM43 PK8.014.01	M. 14 x 2,00 x 39 (cónico 30°)	12.9
2	Reja	WSM40 PK7.013.01 WSM40L PK7.014.01	M. 14 x 2,00 x 39 (cónico 30°)	12.9
3	Puntera	PK8.011.01 PK8.011.02	M. 12 x 1,75 x 38 (cónico)	12.9
4	Vertedera	WY400A PK8.001.09 WY400L PK8.002.09	M. 10 x 1,50 x 30 (2 prisioneros) M. 12 x 1,75 x 30 (2 prisioneros)	8.8
5	Complemento de Vertedera	PK8.005.01 PK8.006.01	M. 10 x 1,50 x 30 (2 prisioneros)	8.8
6	Reja de raseta	LZ 135601 LZ 135701	M. 12 x 1,75 x 30 (cónico)	8.8
7	Vertedera de raseta	LZ 137602 LZ 137702 LZ 136602 LZ 136702	M. 12 x 1,75 x 30 (2 prisioneros)	8.8
8	Talonera	P5801101	M. 12 x 1,75 x 34 (cónico)	12.9



PUNTERA							
Cód. num.	O.E.M.	Modelo B	kg		↑	→	
1207300	PK8.011.01	1210 A-D	1,5	250	65	290	14
1207400	PK8.011.02	1210 A-I	1,5	250	65	290	14



REJA							
Cód. num.	O.E.M.	Modelo B	kg		↑	→	
1207500	WSM40 PK7.013.01	1212 40-D	5,5	200	116	385	13
1207600	WSM40L PK7.014.01	1212 40-I	5,5	200	116	385	13
1207700	WSM43 PK8.013.01	1212 43-D	6,2	200	114	410	13
1207800	WSM43 PK8.014.01	1212 43-I	6,2	200	114	410	13



VERTEDERA							
Cód. num.	O.E.M.	Modelo B	kg		↑	→	
1207900	WY400A PK8.001.09	1872-D	19,7	25	415	905	8
1208000	WY400L PK8.002.09	1872-I	19,7	25	415	905	8



TALONERA							
Cód. num.	O.E.M.	Modelo B	kg		↑	→	
1208805	P5801101	2356	3,15	100	180	214	12

# COMPONENTES PARA ARADO ADAPTABLE A VOGEL & NOOT

PIÈCES D'USURE ADAPTABLES VOGEL & NOOT / COMPONENTS FOR ADAPTABLE PLOUGHING TO FIT VOGEL & NOOT



COMPLEMENTOS							
Cód. num.	O.E.M.	Modelo B	KG	Embalaje	↑	→	≡
1208100	PK8.005.01	1873-D	2,3	100	335	206	8
1208200	PK8.006.01	1873-I	2,3	100	335	206	8

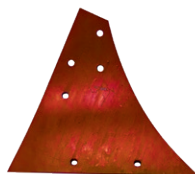

BOCATEJA					
Cód. num.	KG	Embalaje	↑	→	≡
1208300	4,25	250	365	360	6
1208400	4,25	250	365	360	6



REJA DE RASETA						
Cód. num.	O.E.M.	KG	Embalaje	↑	→	≡
1208500	LZ 135601	1,45	50	100	250	8
1208600	LZ 135701	1,45	59	100	150	8



VERTEDERA DE RASETA						
Cód. num.	O.E.M.	KG	Embalaje	↑	→	≡
1208700	LZ 137602	2,67	200	258	357	6
1208800	LZ 137702	2,67	200	258	357	6
1208802	LZ 136602	1,8	200	180	235	6
1208801	LZ 136702	1,8	200	180	235	6

## COMPONENTES PARA ARADO ADAPTABLE A OTROS FABRICANTES

PIÈCES D'USURE ADAPTABLES À AUTRES FABRICANTS / COMPONENTS FOR ADAPTABLE PLOUGHING TO FIT OTHER MANUFACTURERS



VERTEDERA						
Cód. num.	Modelo B	KG	Embalaje	↑	→	≡
1217700	1818-A	2,07	50	200	385	6



REJA						
Cód. num.	Modelo B	KG	Embalaje	↑	→	≡
1217800	1411	1,4	100	90	298	8



COSTANERA						
Cód. num.	Modelo B	KG	Embalaje	↑	→	≡
1217900	2334	0,8	50	80	202	8