



campoagrícola

Fabricación y distribución de repuesto agrícola



Componentes para arado

CATÁLOGO
2022

COMPONENTES PARA ARADO ADAPTABLE A GIL

ADAPTABLE A GIL



NUEVO

VERTEDERA						
Cód. num.	Modelo B	≡	↑	→	KG	📦
1216301	1886-D	8	221	523	5,40	100



REJA						
Cód. num.	Modelo B	≡	↑	→	KG	📦
1216400	1439-D	9	125	360	2,75	100



PUNTERA						
Cód. num.	Modelo B	≡	↑	→	KG	📦
1216500	1435-D	8	60	250	1,05	100
1216600	1435-I	8	60	250	1,05	100

COMPONENTES PARA ARADO ADAPTABLE A GREGOIRE BESSON

ADAPTABLE A GREGOIRE BESSON



PUNTERA							
Cód. num.	O.E.M.	Modelo B	≡	↑	→	KG	📦
1216900	173332	173332-D	15	75	305	2,07	100
1217000	173331	173331-I	15	75	305	2,07	100
1217100	177328	177328-D	15	75	305	2,07	100
1217200	177327	177327-I	15	75	305	2,07	100





REJA							
Cód. num.	O.E.M.	Modelo B	≡	↑	→	KG	📦
1217300	177602	177602-D	14	145	652	6,70	100
1217400	177601	177601-I	14	145	652	6,70	100
1217500	178126	178126-D	14	140	650	6,70	100
1217600	178125	178125-I	14	140	650	6,70	100

COMPONENTES PARA ARADO ADAPTABLE A KVERNELAND

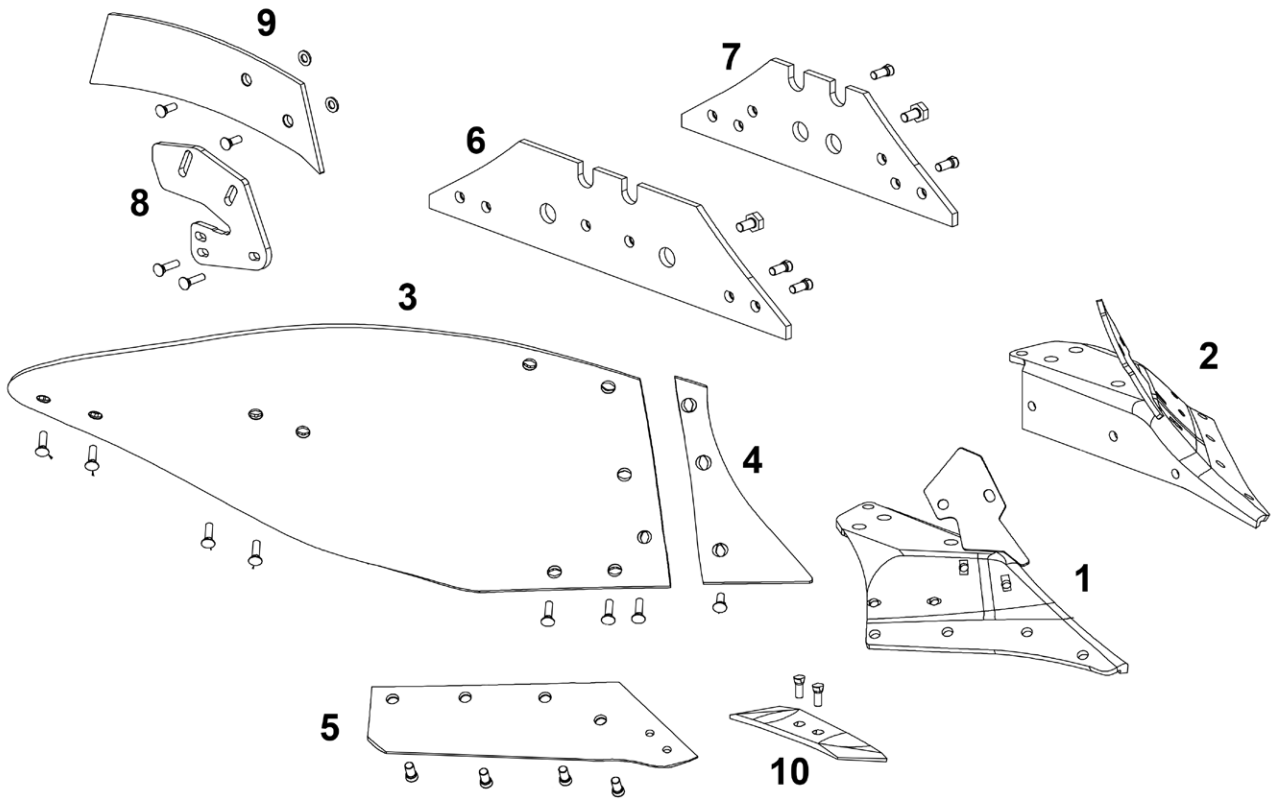
ADAPTABLE A KVERNELAND



Nº	Descripción	O.E.M.		
1	Cuerpo soporte N°9 derecho	73411	-	13.2
2	Cuerpo soporte N°9 izquierdo	73412	-	13.2
3	Vertedera	073286 - 073287 - 073290 - 073291	M. 12 x 1,75 x 35 (2 prisioneros)	10.9
4	Complemento	073230 - 073231 - 073250 - 073251 - 073256 - 073257	M. 12 x 1,75 x 30 (2 prisioneros)	10.9
5	Reja	073004 - 073005 - 073006 - 073007 - 073056 - 073057 - 073080 - 073081	M. 14 x 2,00 x 34 (cónico)	12.9
6	Costanera larga	73609	M. 14 x 2,00 x 45 (cónico)	12.9
7	Costanera corta	73608	M. 14 x 2,00 x 45 (cónico)	12.9
8	Soporte cubre rastros	073310 - 073311	M. 12 x 1,75 x 35 (2 prisioneros)	10.9
9	Cubre rastros	073300 - 073301	M. 12 x 1,75 x 35 (2 prisioneros)	10.9
10	Puntera	053090 - 063090	M. 12 x 1,75 x 38 (cónico)	12.9

COMPONENTES PARA ARADO ADAPTABLE A KVERNELAND



VERTEDERA							
Cód. num.	O.E.M.	Modelo B	KG	≡	↑	→	📦
1200401	73286	N° 8 1797-D	20,90	8	477	1.059	25
1200101	73287	N° 8 1797-I	20,90	8	477	1.059	25
1200300	73290	N° 9 1834-D	20,70	8	440	980	25
1200400	73291	N° 9 1834-I	20,70	8	440	980	25



COMPLEMENTOS							
Cód. num.	O.E.M.	Modelo B	KG	≡	↑	→	📦
1200500	73230	N° 19 1849-D	1,80	8	325	160	100
1200600	73231	N° 19 1849-I	1,80	8	325	160	100
1200700	73250	N° 7-8 1798-D	1,50	8	278	162	100
1200800	73251	N° 7-8 1798-I	1,50	8	278	162	100
1200900	73256	N° 9-1835-D	1,60	8	325	166	100
1201000	73257	N° 9-1835-I	1,60	8	325	166	100



NUEVO

PUNTERA							
Cód. num.	O.E.M.	Modelo B	KG	≡	↑	→	📦
1202100	53090	1365-D	1,30	12	65	260	500
1202200	63090	1365-I	1,30	12	65	260	500
1202300	053090-15	1365-D-15	1,60	15	65	260	500
1202400	063090-15	1365-I-15	1,60	15	65	260	500
1202500	053090-CN	-	2,40	13	65	235	500
1202600	063090-CN	-	2,40	13	65	235	500



REJA							
Cód. num.	O.E.M.	Modelo B	KG	≡	↑	→	📦
1201200	73004	1374 16-D	5,50	12	142	370	200
1201400	73005	1374 16-I	5,50	12	142	370	200
1201500	73006	1374 18-D	6,40	12	142	450	200
1201600	73007	1374 18-I	6,40	12	142	450	200
1201700	73056	1434 16-D	5,80	13	144	380	200
1201800	73057	1434 16-I	5,80	13	144	380	200
1201900	73080	1434 18-D	6,30	13	144	465	200
1202000	73081	1434 18-I	6,30	13	144	465	200



CUERPO SOPORTE N° 9			
Cód. num.	O.E.M.	KG	📦
1202700	073411-D	13,20	15
1202800	073412-I	13,20	15

COMPONENTES PARA ARADO ADAPTABLE A KVERNELAND



COSTANERA							
Cód. num.	O.E.M.	Modelo B	KG	Espejor	↑	→	Embalaje
1202900	73608	2327	5,25	12	170	566	100
1203000	73609	2328	7,90	12	170	746	100



REFUERZO DE COSTANERA							
Cód. num.	Modelo B	KG	Espejor	↑	→	Embalaje	
1203100	2327 PROTECT	4,20	12	90	566	100	
1203200	2328 PROTECT	5,75	12	90	746	100	



SOPORTE CUBRERASTROJOS							
Cód. num.	O.E.M.	Modelo B	KG	Espejor	↑	→	Embalaje
1203300	73310	1860-D	2,15	10	200	220	250
1203400	73311	1860-I	2,15	10	200	220	250



CUBRERASTROJOS							
Cód. num.	O.E.M.	Modelo B	KG	Espejor	↑	→	Embalaje
1203500	73300	1857-D	3,29	8	160	460	250
1203600	73301	1857-I	3,29	8	160	460	250

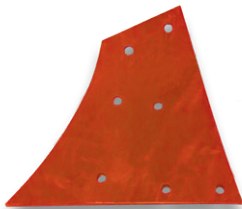

BOCATEJA							
Cód. num.	Modelo B	KG	Espejor	↑	→	Embalaje	
1203700	1835-D-PRO	4,50	7	365	387	250	
1203800	1835-I-PRO	4,50	7	365	387	250	
1200100	1798-D-PRO	3,60	7	374	325	250	
1200200	1798-I-PRO	3,60	7	374	325	250	



REJA DE RASETA							
Cód. num.	O.E.M.	Modelo B	KG	Espejor	↑	→	Embalaje
1204100	66868	1394-D	1,55	8	100	330	200
1204200	66869	1394-I	1,55	8	100	330	200
1204403	56873	1386-D	1,05	8	100	190	200
1204404	66873	1386-I	1,05	8	100	190	200



VERTEDERA DE RASETA							
Cód. num.	O.E.M.	Modelo B	KG	Espejor	↑	→	Embalaje
1204300	66878	1818-D	1,40	4	175	360	50
1204400	66879	1818-I	1,40	4	175	360	50
1204401	66880	1819-D	1,35	4	155	360	50
1204402	66881	1819-I	1,35	4	155	360	50

COMPONENTES PARA ARADO ADAPTABLE A KUHN/HUARD

ADAPTABLE A KUHN/HUARD

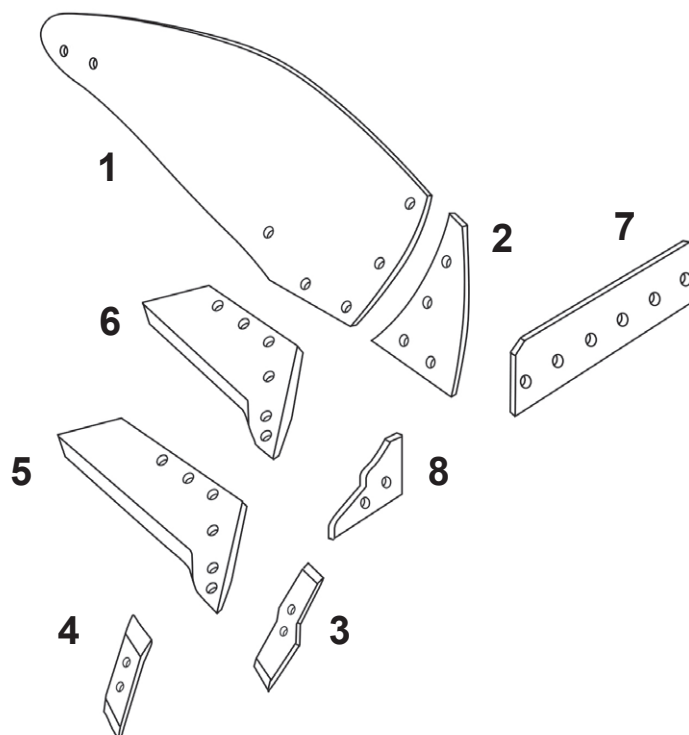

N°	Descripción	O.E.M.	📏	☑
1	Vertedera	616138 - 616139 - 612108 - 612109	M. 12 x 1,75 x 30 (2 prisioneros)	8.8
			M. 12 x 1,75 x 35 (2 prisioneros)	8.8
2	Complemento	619172 - 619173	M. 12 x 1,75 x 35 (2 prisioneros)	10.9
3	Punta Marathon	622128 - 622129	M. 12 x 1,75 x 34 (cónico)	12.9
4	Puntera	622180 - 622181	M. 12 x 1,75 x 34 (cónico)	12.9
5	Reja 14"	622134 - 622135 - 622140 - 622141 - 622166 - 622167	M. 14 x 2,00 x 35 (2 prisioneros)	8.8
6	Reja 16"	622212 - 622213 - 622136 622137 - 622142 - 622143 622172 - 622173	M. 14 x 2,00 x 35 (2 prisioneros)	8.8
7	Costanera	279140	M. 12 x 1,75 x 34 (cónico)	12.9
8	Punta de costanera	279138 - 279139	M. 12 x 1,75 x 34 (cónico)	12.9



PUNTERA							
Cód. num.	O.E.M.	Modelo B	📊	📦	↑	→	≡
1204500	622128	1385-D	1,85	250	85	300	12
1204600	622129	1385-I	1,85	250	85	300	12
1204700	622180	1388-D	1,85	250	85	300	12
1204800	622181	1388-I	1,85	250	85	300	12

COMPONENTES PARA ARADO ADAPTABLE A KUHN/HUARD



REJA							
Cód. num.	O.E.M.	Modelo B	KG	Es	↑	→	Em
1204601	622212	1383-16-LD	6,20	12	158	671	200
1204602	622213	1383-16-LI	6,20	12	158	671	200
1204900	622134	1383 14-D	5,30	12	158	587	200
1205000	622135	1383 14-I	5,30	12	158	587	200
1205100	622136	1383 16-D	6,00	12	258	671	200
1205200	622137	1383 16-I	6,00	12	258	671	200
1205300	622140	1384 14-D	5,50	12	158	587	150
1205400	622141	1384 14-I	5,50	12	158	587	150
1205500	622142	1384 16-D	6,20	12	158	671	150
1205600	622143	1384 16-I	6,20	12	158	671	150
1205700	622166	1430 14-D	5,30	10	173	570	150
1205800	622167	1430 14-I	5,30	10	173	570	150
1205900	622172	1430 16-D	5,70	10	173	654	150
1206000	622173	1430 16-I	5,70	10	173	654	150



COMPLEMENTOS							
Cód. num.	O.E.M.	Modelo B	KG	Es	↑	→	Em
1206100	619172	1430-16D	2,50	8	160	139	150
1206200	619173	1430-16I	2,50	8	160	139	150



REJA DE RASETA							
Cód. num.	O.E.M.	Modelo B	KG	Es	↑	→	Em
1206300	631100	1433 D	1,40	10	107	270	50
1206310	631101	1433 I	1,40	10	107	270	50
1206500	631102	1372 D	1,30	8	97	280	50
1206600	631103	1372 I	1,30	8	97	280	50
1206700	631108	-	1,56	10	107	275	50
1206800	631109	-	1,56	10	107	275	50



COSTANERA							
Cód. num.	O.E.M.	Modelo B	KG	Es	↑	→	Em
1207200	279140	2329 C	5,50	10	130	550	50
1207203	279138	2346-D	0,90	10	76	155	50
1207204	279139	2346-I	0,90	10	76	155	50

COMPONENTES PARA ARADO ADAPTABLE A LANAU

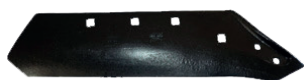

REJA							
Cód. num.	Modelo B	KG	Es	↑	→	Em	
1216700	1383-14 DCA	6,00	12	158	587	100	
1216800	1383-14 ICA	6,00	12	158	587	100	





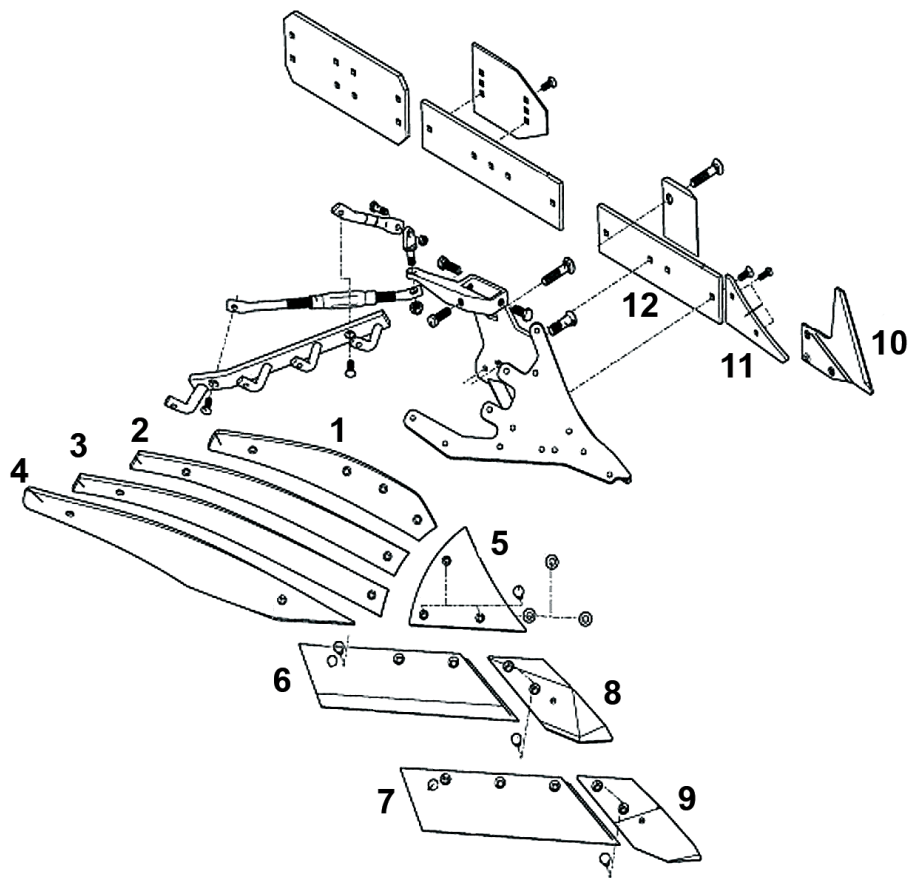

COMPONENTES PARA ARADO ADAPTABLE A LEMKEN

ADAPTABLE A LEMKEN

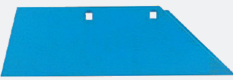
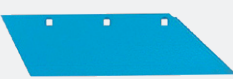
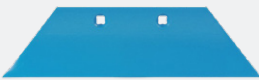
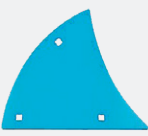

N°	Descripción	O.E.M.		
1	Lámina 1	3444010 - 3444011 - 3444110 - 3444111	M. 10 x 1,50 x 45 (608)	12.9
2	Lámina 2	3444020 - 3444021 - 3444120 - 3444121	M. 10 x 1,50 x 45 (608)	12.9
3	Lámina 3	3444030 - 3444031 - 3444130 - 3444131	M. 10 x 1,5 x 45 (608)	12.9
4	Lámina 4	3444042 - 3444043 - 3444140 - 3444141	M. 10 x 1,50 x 45 (608)	12.9
5	Complemento de vertedera	3451002 - 3451003 - 3451004 - 3451005	M. 10 x 1,50 x 33 (608)	12.9
6	Reja	3352030 - 3352031	M. 12 x 1,75 x 33 (608)	10.9
7	Reja	3352034 - 3352035	M. 12 x 1,75 x 33 (608)	10.9
8	Punta-reja Hard Face	3364150 - 3364151	M. 12 x 1,75 x 50 (608)	12.9
9	Punta	3364050 - 3364051	M. 12 x 1,75 x 50 (608)	12.9
10	Cuchilla de talonera	3492890 - 3492891	M. 10 x 1,50 x 45 (608)	12.9
11	Triángulo de talonera	3401900 - 3401901	M. 10 x 1,50 x 33 (608)	12.9
12	Talonera	3411504	M. 12 x 1,75 x 33 (608)	10.9

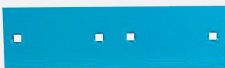

COMPONENTES PARA ARADO ADAPTABLE A LEMKEN

ARADO							
Modelo	Cód. num.	Descripción	O.E.M.	KG	↑	→	≡
	1208900 1209000	PUNTA-REJA HARDFACE	3364150 3364151	2,50	105	350	19
	1209100 1209200	PUNTA-REJA	3364050 3364051	2,00	105	350	19
	1209300 1209400	PUNTA REVERSIBLE	3365540 3365541	2,00	100	370	12
	1209500 1209600	REJA 2 AGUJEROS	3352030 3352031	4,00	150	500	10
	1209700 1209800	REJA 3 AGUJEROS	3352034 3352035	4,50	150	570	10
	1209900	REJA DE RASETA REVERSIBLE	3363724	1,60	105	365	10
	1211600 1211700 1211800 1211900	COMPLEMENTO DE VERTEDERA	3451002 3451003 3451004 3451005	3,50 2,20	235	240	10
	1212000 1212100	VERTEDERA DE RASETA	3470600 3470601	6,00	-	-	10
	1212200 1212300	CUCHILLA DE TALONERA	3492890 3492891	1,55	240	240	10
	1212400 1212500	TRIÁNGULO DE TALONERA	3401900 3401901	1,00	120	190	10
	1212600	TALONERA	3411504	4,70	120	420	10

COMPONENTES PARA ARADO ADAPTABLE A VOGEL & NOOT

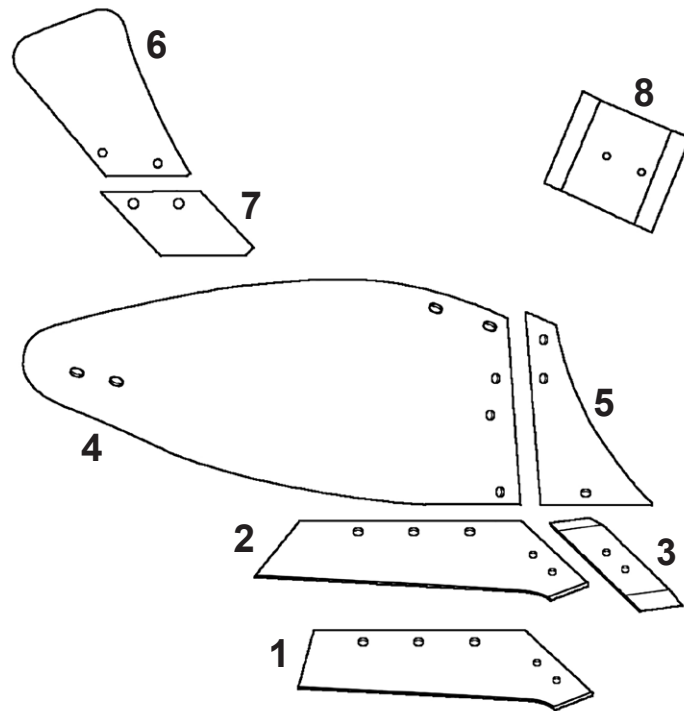
ADAPTABLE A VOGEL & NOOT



N°	Descripción	O.E.M.		
1	Reja	WSM43 PK8.013.01 WSM43 PK8.014.01	M. 14 x 2,00 x 39 (cónico 30°)	12.9
2	Reja	WSM40 PK7.013.01 WSM40L PK7.014.01	M. 14 x 2,00 x 39 (cónico 30°)	12.9
3	Puntera	PK8.011.01 PK8.011.02	M. 12 x 1,75 x 38 (cónico)	12.9
4	Vertedera	WY400A PK8.001.09 WY400L PK8.002.09	M. 12 x 1,50 x 30 (2 prisioneros) M. 14 x 1,75 x 30 (2 prisioneros)	8.8
5	Complemento de Vertedera	PK8.005.01 PK8.006.01	M. 10 x 1,50 x 30 (2 prisioneros)	8.8
6	Reja de raseta	LZ 135601 LZ 135701	M. 12 x 1,75 x 30 (cónico)	8.8
7	Vertedera de raseta	LZ 137602 LZ 137702 LZ 136602 LZ 136702	M. 12 x 1,75 x 30 (2 prisioneros)	8.8
8	Talonera	P5801101	M. 12 x 1,75 x 34 (cónico)	12.9

COMPONENTES PARA ARADO ADAPTABLE A VOGEL & NOOT

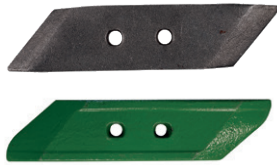

PUNTERA							
Cód. num.	O.E.M.	Modelo B	KG	≡	↑	→	📦
1207300	PK8.011.01	1210 A-D	1,50	14	65	290	250
1207400	PK8.011.02	1210 A-I	1,50	14	65	290	250
1234500	PK8.011.01A	D	1,55	14	65	290	250
1234600	PK8.011.02A	I	1,55	14	65	290	250



REJA							
Cód. num.	O.E.M.	Modelo B	KG	≡	↑	→	📦
1207500	WSM40 PK7.013.01	1212 40-D	5,50	13	116	385	200
1207600	WSM40L PK7.014.01	1212 40-I	5,50	13	116	385	200
1207700	WSM43 PK8.013.01	1212 43-D	6,20	13	114	410	200
1207800	WSM43 PK8.014.01	1212 43-I	6,20	13	114	410	200



VERTEDERA							
Cód. num.	O.E.M.	Modelo B	KG	≡	↑	→	📦
1207900	WY400A PK8.001.09	1872-D	19,70	8	415	905	25
1208000	WY400L PK8.002.09	1872-I	19,70	8	415	905	25



TALONERA							
Cód. num.	O.E.M.	Modelo B	KG	≡	↑	→	📦
1208805	P5801101	2356	3,15	12	180	214	100



COMPLEMENTOS							
Cód. num.	O.E.M.	Modelo B	KG	≡	↑	→	📦
1208100	PK8.005.01	1873-D	2,30	8	335	206	100
1208200	PK8.006.01	1873-I	2,30	8	335	206	100

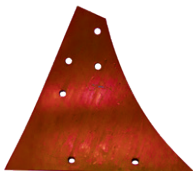

BOCATEJA							
Cód. num.	KG	≡	↑	→	📦		
1208300	4,25	6	365	360	250		
1208400	4,25	6	365	360	250		



REJA DE RASETA							
Cód. num.	O.E.M.	KG	≡	↑	→	📦	
1208500	LZ 135601	1,45	8	100	250	50	
1208600	LZ 135701	1,45	8	100	150	59	

COMPONENTES PARA ARADO ADAPTABLE A VOGEL & NOOT



VERTEDERA DE RASETA						
Cód. num.	O.E.M.	KG	≡	↑	→	📦
1208700	LZ 137602	2,67	6	258	357	200
1208800	LZ 137702	2,67	6	258	357	200
1208802	LZ 136602	1,80	6	180	235	200
1208801	LZ 136702	1,80	6	180	235	200

COMPONENTES PARA ARADO ADAPTABLE A ÖVERUM



NUEVO VERTEDERA							
Cód. num.	O.E.M.	Modelo B	KG	≡	↑	→	📦
1217601	94594	1848-D	19,50	8	421	1022	25
1217602	94595	1848-I	19,50	8	421	1022	25



NUEVO REJA							
Cód. num.	O.E.M.	Modelo B	KG	≡	↑	→	📦
1217603	94600	1446-16-D	3,60	11	150	467	50
1217604	94601	1446-16-I	3,60	11	150	467	50



NUEVO PUNTERA							
Cód. num.	O.E.M.	Modelo B	KG	≡	↑	→	📦
1217605	94608	1442-D	1,80	12	100	315	100
1217606	94609	1442-I	1,80	12	100	315	100



NUEVO COSTANERA							
Cód. num.	O.E.M.	Modelo B	KG	≡	↑	→	📦
1217607	063600A	2319	1,40	12	70	240	100

COMPONENTES PARA ARADO ADAPTABLE A OTROS FABRICANTES



REJA						
Cód. num.	Modelo B	KG	≡	↑	→	📦
1217800	1411-D	1,40	8	90	298	100