



# campoagrícola

Fabricación y distribución de repuesto agrícola





## Cultivadores europeos

CATÁLOGO  
**2022**

# CULTIVADORES EUROPEOS

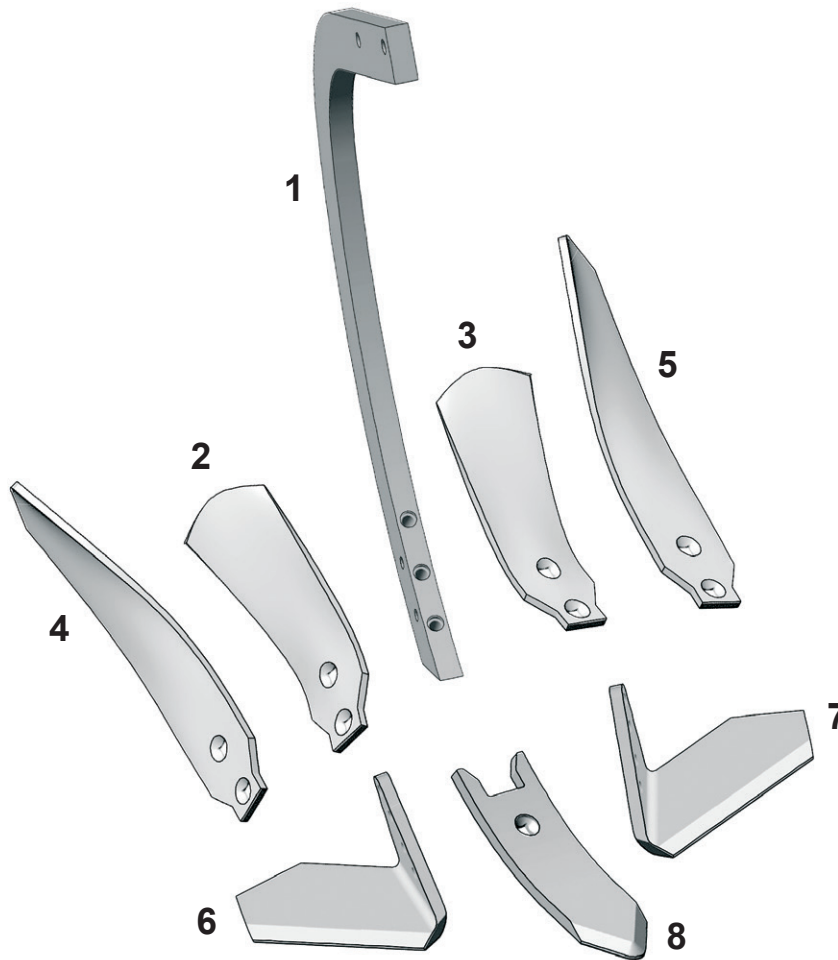
## ADAPTABLE A HORSCH TERRANO



N°	Descripción	O.E.M.		
1	Brazo	34060836		
2	Deflector corto derecho	34060863	M. 12 x 90 (608)	12.9
3	Deflector corto izquierdo	34060862	M. 12 x 90 (608)	12.9
4	Deflector largo derecho	34060859	M. 12 x 90 (608)	12.9
5	Deflector largo izquierdo	34060858	M. 12 x 90 (608)	12.9
6	Aleta derecha	34060857	M. 12 x 70 (608)	12.9
7	Aleta izquierda	34060856	M. 12 x 70 (608)	12.9
8	Punta	34060850	M. 12 x 90 (608)	12.9



# CULTIVADORES EUROPEOS

HORSCH TERRANO								
Modelo	Cód. num.	Descripción	O.E.M.	Modelo B				
	1217610	Punta	34060850	15055-A80	1,80	230	120	10
	1217611	Aleta izquierda	34060856	15056-A	1,90	195	105	10
	1217612	Aleta derecha	34060857	15056-A	1,90	195	105	10
	1217615	Deflector largo derecho	34060859	15057-A-80-D-HRS	1,90	420	80	8
	1217616	Deflector largo izquierdo	34060858	15057-A-80-I-HRS	1,90	420	80	8
	1217613	Deflector corto derecho	34060863	15058-A-80-D-HRS	1,20	270	80	8
	1217614	Deflector corto izquierdo	34060862	15058-A-80-I-HRS	1,20	270	80	8
	1217619	Deflector corto derecho Modelo especial Campoagrícola	-	-	1,20	270	80	8
	1217620	Deflector corto izquierdo Modelo especial Campoagrícola	-	-	1,20	270	80	8
	1241000	Brazo	34060836	2823-C (60 x 25)	12,20	715	357	25

# CULTIVADORES EUROPEOS

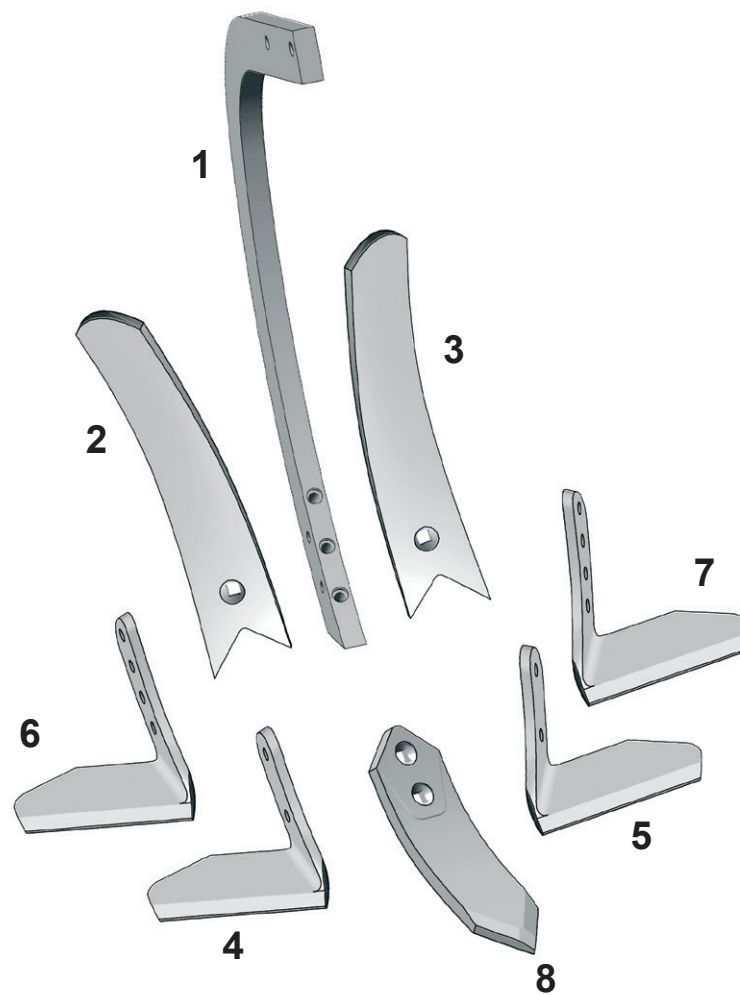
## ADAPTABLE A KUHN CULTIMER



N°	Descripción	O.E.M.		
1	Brazo			
2	Deflector derecho	2212680	M. 12 x 75 (608)	12.9
3	Deflector izquierdo	2212690	M. 12 x 75 (608)	12.9
4	Aleta 2 agujeros derecha	2212500	M. 12 x 70 (608)	12.9
5	Aleta 2 agujeros izquierda	2212510	M. 12 x 70 (608)	12.9
6	Aleta 4 agujeros derecha	2212501	M. 12 x 70 (608)	12.9
7	Aleta 4 agujeros izquierda	2212511	M. 12 x 70 (608)	12.9
8	Punta	2212540	M. 12 x 80 (608)	12.9

# CULTIVADORES EUROPEOS

KUH N CULTIMER							
Modelo	Cód. num.	Descripción	O.E.M.	 KG			
	1224100	Punta	2212540	1,73	285	80	15
	1224200	Aleta 4 agujeros derecha	2212501	1,90	200	80	10
	1224300	Aleta 4 agujeros izquierda	2212511	1,90	200	80	10
	1224400	Aleta 2 agujeros derecha	2212500	1,90	200	80	10
	1224500	Aleta 2 agujeros izquierda	2212510	1,90	200	80	10
	1224600	Deflector derecho	2212680	1,89	410	80	10
	1224700	Deflector izquierdo	2212690	1,89	410	80	10

# CULTIVADORES EUROPEOS

## ADAPTABLE A LEMKEN SMARAGD

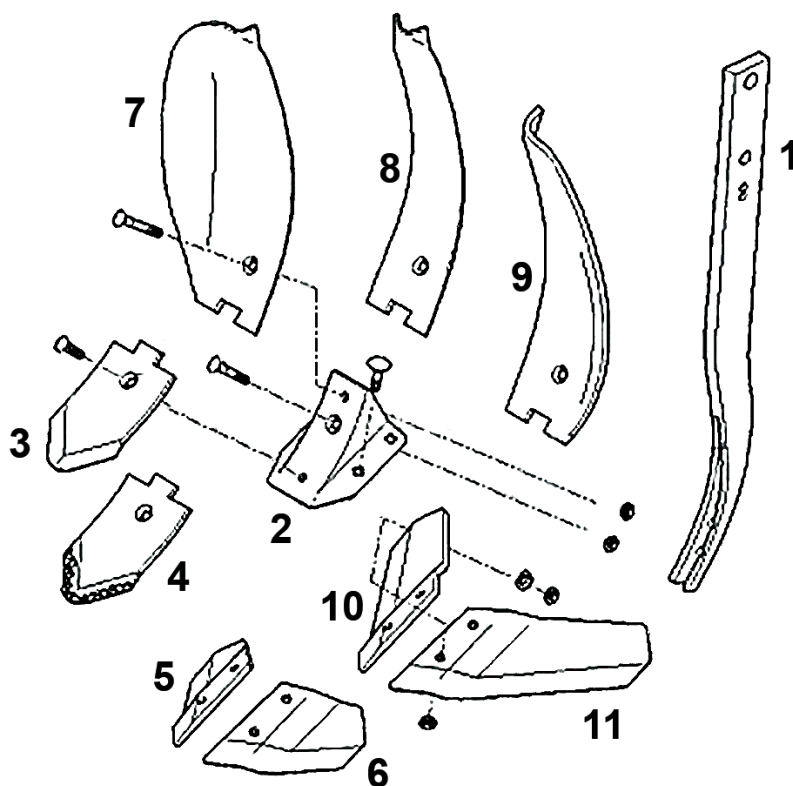

N°	Descripción	O.E.M.	🔩	☑
1	Brazo forjado Lemken Smaragd	4653680	M. 24 M20 2,00 x M12 (603)	-
2	Soporte Central	4679105	M. 12 x 1,75 x 35 (603)	10.9
3	Punta	3374388	M. 12 x 1,75 x 35 (608)	10.9
4	Punta Hard Faced	3374392	M. 12 x 1,75 x 35 (608)	10.9
5	Aleta quebrada derecha	3374418	M. 12 x 1,75 x 30 (608)	10.9
6	Aleta quebrada Izquierda	3374419	M. 12 x 1,75 x 30 (608)	10.9
7	Deflector derecho	3374398	M. 12 x 1,75 x 65 (608)	12.9
8	Deflector central	3374395	M. 12 x 1,75 x 65 (608)	12.9
9	Deflector izquierdo	3374399	M. 12 x 1,75 x 65 (608)	12.9
10	Aleta derecha	3374416	M. 12 x 1,75 x 30 (608)	10.9
11	Aleta Izquierda	3374417	M. 12 x 1,75 x 30 (608)	10.9





# CULTIVADORES EUROPEOS

LEMKEN SMARAGD								
Modelo	Cód. num.	Descripción	O.E.M.	Modelo B	 KG			
	1212700	Soporte central 195 X 150 x 10	4679105	1595 10 CA	2,35	195	150	10
	1212800	Aleta quebrada derecha 350 X 130 x 10	3374418	1516 10 D CA	2,10	350	130	10
	1212900	Aleta quebrada izquierda 350 X 130 x 10	3374419	1516 10 I CA	2,10	350	130	10
	1213000	Aleta quebrada Hard faced derecha 350 X 130 x 0	3374425	-	2,65	350	130	10
	1213100	Aleta quebrada Hard faced Izquierda 350 X 130 x 10	3374424	-	2,65	350	130	10
	1213200	Aleta derecha 350 X 130 x 10	3374416	1596 10 D CA	2,05	350	130	10
	1213300	Aleta izquierda 350 X 130 x 10	3374417	1596 10 I CA	2,05	350	130	10
	1213400	Punta 230 X 120 x 10	3374388	1515 10 CA	2,05	230	120	10
	1213500	Punta Hard faced 235 X 120 x 12	3374392	1515 12 CA AP2	2,20	230	120	12
	1213600	Deflector central 295 X 100 x 8	3374395	1597 A 8 CA	1,85	295	100	8
	1213700	Deflector derecho 300 X 110 x 8	3374398	1598 8 D CA	2,40	300	110	8
	1213800	Deflector Izquierdo 300 X 110 x 8	3374399	1598 8 I CA	2,40	300	110	8

# CULTIVADORES EUROPEOS

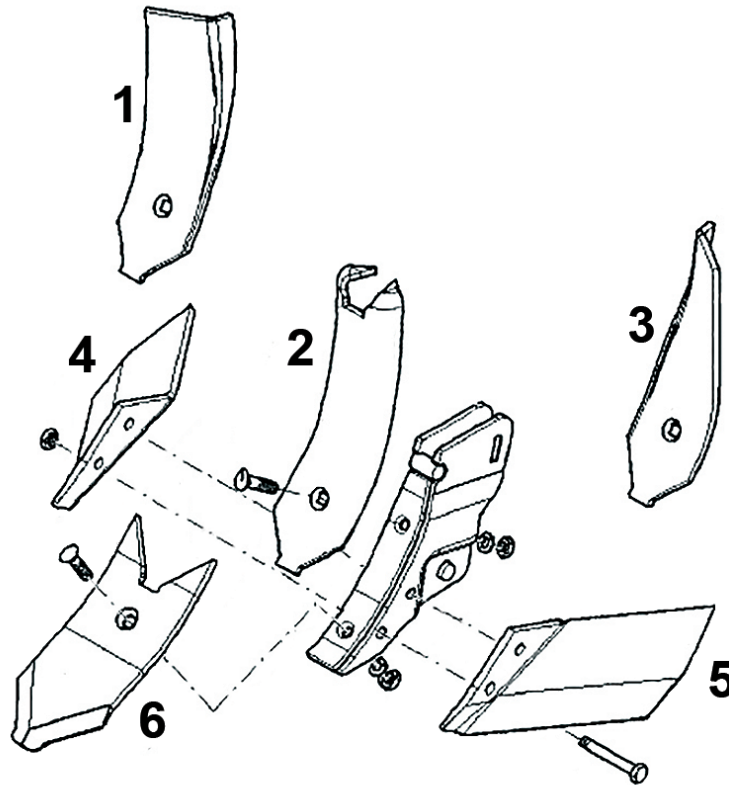

## ADAPTABLE A LEMKEN KRISTALL



Nº	Descripción	O.E.M.		
1	Deflector derecho	3374490	M. 12 x 1,75 x 75 (608)	12.9
2	Deflector central	3374484	M. 12 x 1,75 x 75 (608)	12.9
3	Deflector izquierdo	3374491	M. 12 x 1,75 x 75 (608)	12.9
4	Aleta derecha	3374530 - 3374536 - 3374540	M. 12 x 1,75 x 70 (608)	12.9
5	Aleta izquierda	3374531 - 3374537 - 3374541	M. 12 x 1,75 x 70 (608)	12.9
6	Punta	3374443	M. 12 x 1,75 x 50 (608)	12.9





# CULTIVADORES EUROPEOS

LEMKEN KRISTALL							
Modelo	Cód. num.	Descripción	O.E.M.	 KG			
	1214400	Deflector derecho	3374490	1,90	320	100	8
	1214500	Deflector izquierdo	3374491	1,90	320	100	8
	1215000	Deflector central	3374484	2,00	335	100	8
	1215100	Aleta derecha 340	3374530	2,96	-	340	10
	1215200	Aleta izquierda 340	3374531	2,96	-	340	10
	1215300	Aleta derecha 370	3374536	3,26	-	370	10
	1215400	Aleta izquierda 370	3374537	3,26	-	370	10
	1215500	Aleta derecha 400	3374540	3,51	-	400	10
	1215600	Aleta izquierda 400	3374541	3,51	-	400	10
	1215700	Punta	3374442	2,50	285	120	12



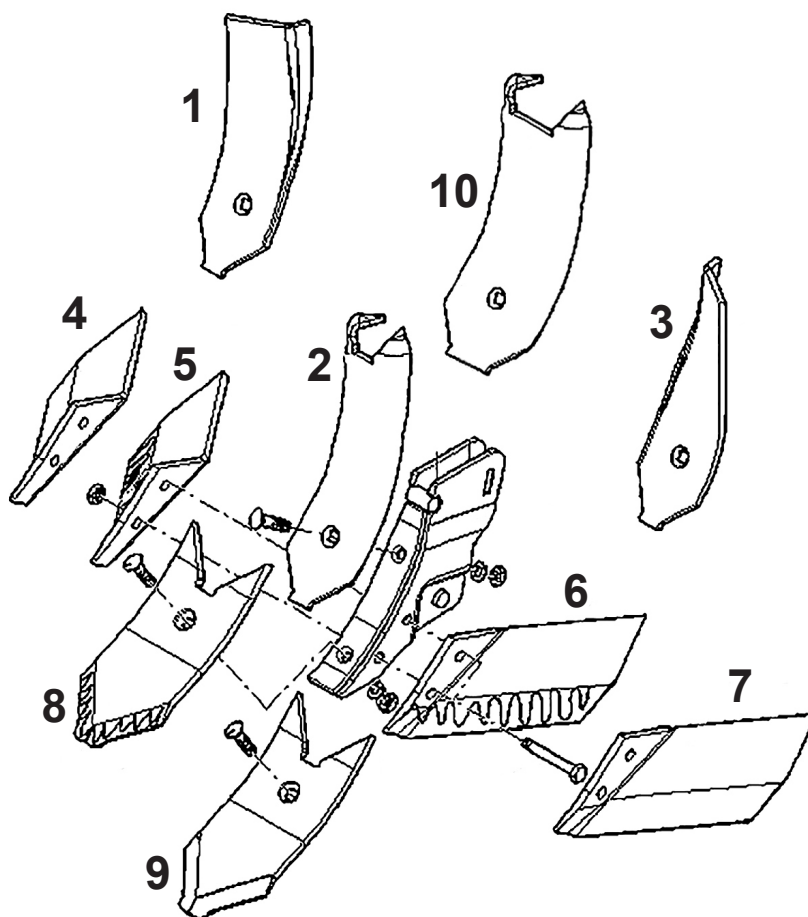













# CULTIVADORES EUROPEOS

## ADAPTABLE A LEMKEN KARAT



Nº	Descripción	O.E.M.		
1	Deflector derecho	3374490	M. 12 x 1,75 x 75 (608)	12.9
2	Deflector central	3374482	M. 12 x 1,75 x 75 (608)	12.9
3	Deflector izquierdo	3374491	M. 12 x 1,75 x 75 (608)	12.9
4	Aleta derecha	3374460	M. 12 x 1,75 x 70 (608)	12.9
5	Aleta derecha Hard Face	3374462	M. 12 x 1,75 x 70 (608)	12.9
6	Aleta izquierda Hard Face	3374463	M. 12 x 1,75 x 70 (608)	12.9
7	Aleta izquierda	3374461	M. 12 x 1,75 x 70 (608)	12.9
8	Punta Hard Face	3374443	M. 12 x 1,75 x 50 (608)	12.9
9	Punta standard	3374442	M. 12 x 1,75 x 50 (608)	12.9
10	Deflector central ancho	3374484	M. 12 x 1,75 x 75 (608)	12.9

# CULTIVADORES EUROPEOS

LEMKEN KARAT							
Modelo	Cód. num.	Descripción	O.E.M.	 KG			
	1214000	Punta 280 x 120 x 10	3374442	2,00	280	120	10
	1214100	Punta hard faced 280 x 120 x 12	3374443	2,40	280	120	12
	1214200	Punta hard faced 260 x 80 x 15	3374441	2,60	260	80	15
	1214201	Punta 260 x 80 x 15	-	2,60	260	80	15
	1214300	Deflector central 335 x 80 x 8	3374482	1,60	335	80	8
	1214400	Deflector derecho 320 x 100 x 8	3374490	1,90	330	100	8
	1214500	Deflector izquierdo 320 x 100 x 8	3374491	1,90	330	100	8
	1214600	Aleta derecha 341 x 130 x 10	3374460	2,60	341	130	10
	1214700	Aleta izquierda 341 x 130 x 10	3374461	2,60	341	130	10
	1214800	Aleta hard faced derecha 341 x 130 x 10	3374462	2,80	341	130	10
	1214900	Aleta hard faced izquierda 341 x 130 x 10	3374463	2,80	341	130	10
	1215000	Deflector central ancho 335 x 100 x 8	3374484	2,00	335	100	8