



# campoagrícola

La calidad es nuestro punto de partida

La qualité est notre point de départ

Quality is our starting point

CATÁLOGO  
**2023**

## Conjuntos chisel



## CONJUNTOS CHISEL

Conjunto chisel de fácil montaje. Muelle alojado dentro del tubo, garantizando la seguridad y permitiendo regular la presión del muelle.

Casquillos de nylon.

Cuerpo en acero fundido, calidad muy superior a la fundición nodular utilizada habitualmente en el mercado.

Instrucciones  
de montaje:



Brazos Bianchi, los más duraderos del mercado europeo, casquillos de nylon, tornillos de acero 8.8 - 10.9, pintura Epoxi, cuerpos de acero fundido.

# MODELOS CONJUNTOS CHISEL

## Modelos disponibles



### BRAZO 70 x 30

Cód. num.	Modelo	Bastidor	Muelle	KG	A	B	C	D
1801414	CC703010 Rastrojero	100 x 100	390 x 90 x 20 390 x 48 x 11	60,39	860	770	730	190

### BRAZO 40 x 40

Cód. num.	Modelo	Bastidor	Muelle	KG	A	B	C	D
1800100	CC404010	100 x 100	390 x 90 x 20 390 x 48 x 11	62,29	754	663	641	166
1800225	CC404010L Modelo alto		390 x 90 x 20 390 x 48 x 11	63,49	829	743	719	166

### BRAZO 40 x 30

Cód. num.	Modelo	Bastidor	Muelle	KG	A	B	C	D
1800300	CC40301010L Modelo alto	100 x 100	300 x 90 x 18	42,44	617	726	511	130
1800400	CC403010100		300 x 90 x 18	41,41	617	690	515	130
1800500	CC403080800	80 x 80	300 x 90 x 18	40,25	617	592	542	130

### BRAZO 35 x 35

Cód. num.	Modelo	Bastidor	Muelle	KG	A	B	C	D
1800600	CC353510100	100 x 100	300 x 90 x 18	41,21	601	692	548	130
<b>NUEVO</b> 1800750	CC353510100V-D Viñero derecho		300 x 90 x 18	41,21	601	692	548	130
<b>NUEVO</b> 1800650	CC353510100V-I Viñero izquierdo		300 x 90 x 18	41,21	601	692	548	130
1800700	CC353580800	80 x 80	300 x 90 x 18	40,05	601	692	548	130
<b>NUEVO</b> 1801750	CC353580800V-D Viñero derecho		300 x 90 x 18	40,05	601	692	548	130
<b>NUEVO</b> 1801650	CC353580800V-I Viñero izquierdo		300 x 90 x 18	40,05	601	692	548	130

### BRAZO 30 x 30

Cód. num.	Modelo	Bastidor	Muelle	KG	A	B	C	D
1800800	CC303080800	80 x 80	250 x 90 x 16	36,16	560	603	407	130
1800901	CC30308080V-I Viñero izquierdo curvo		250 x 90 x 16	36,66	560	603	407	130
1800900	CC30308080V-D Viñero derecho curvo		250 x 90 x 16	36,66	560	603	407	130

### BRAZO 32 x 32

Cód. num.	Modelo	Bastidor	Muelle	KG	A	B	C	D
1801100	CC323280800	80 x 80	250 x 90 x 16	36,96	560	603	407	130

# DESPIECE CONJUNTOS CHISEL

**Modelo CC703010**

**Cód. num. 1801414**

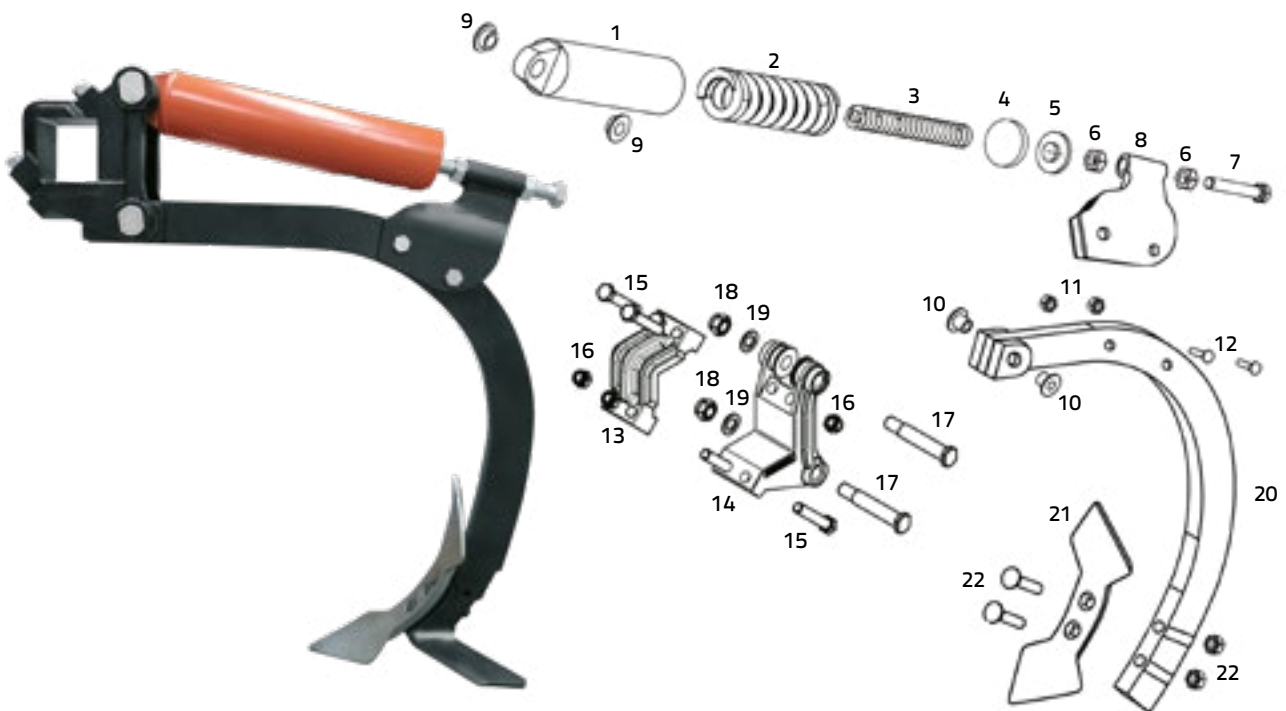

Nº	Modelo	Código	Descripción	Características	KG
1		<b>1803603</b>	Tubo protector del muelle	40 x 40	3,10
2		<b>0802100</b>	Muelle exterior	390 x 90 x 20	8,20
3		<b>0800100</b>	Muelle interior	390 x 48 x 11	2,20
4		<b>1801801</b>	Tapa nylon sujeción muelle		0,10
5		<b>1805200</b>	Tapa metálica sujeción muelle	M. 24	0.15
6		<b>4554700</b>	Tuerca regulación presión (x2)	D-934 M. 24	0,11
7		<b>4539300</b>	Tornillo regulación presión	D-933 8.8 M. 24 x 220	0,78
8		<b>1803400</b>	Soporte brazo		4,00
9		<b>1802100</b>	Casquillo nylon superior (x2)		0,11
10		<b>1802200</b>	Casquillo nylon inferior (x2)		0,11

## DESPIECE CONJUNTOS CHISEL

N°	Modelo	Código	Descripción	Características	KG
11		<b>5007100</b>	Tuerca tornillo amarre soporte	D-985 M. 16	0,03
12		<b>4440900</b>	Tornillo amarre soporte	D-931 8.8 M. 16 x 80	0,15
13		<b>1802501</b>	Brida de amarre	40 x 40 CH 100 x 100	4,80
14		<b>1801502</b>	Cabeza chisel	40 x 40	11,70
15		<b>4444200</b>	Tornillo fijación brida-cabeza (x4)	D-931 8.8 M. 18 x 110	0,26
16		<b>5007200</b>	Tuerca tornillo fijación brida-cabeza (x4)	D-985 M. 18	0,05
17		<b>3419200</b>	Tornillo bulón (x2)	M. 22 x 150 10.9	0,55
18		<b>5002400</b>	Tuerca tornillo bulón (x2)	D-980 M. 22	0,08
19		<b>2819300</b>	Arandela plana tornillo bulón (x2)	D-125 M. 22	0,02
20		<b>1803600</b>	Brazo chisel	70 x 30	17,00
21		<b>0102200</b>	Reja	577B DOBLE CORAZÓN	3,70
22		<b>3411700</b>	Tuercas y tornillos reja (x2)	D-608 / 934 M. 12 x 80	0,09





El chisel de alto despeje es una máquina muy versátil, adaptable a condiciones variables de terreno, tipo de labor y profundidad de trabajo (de 10 a 40 cm. dependiendo del modelo de reja montada)

# DESPIECE CONJUNTOS CHISEL

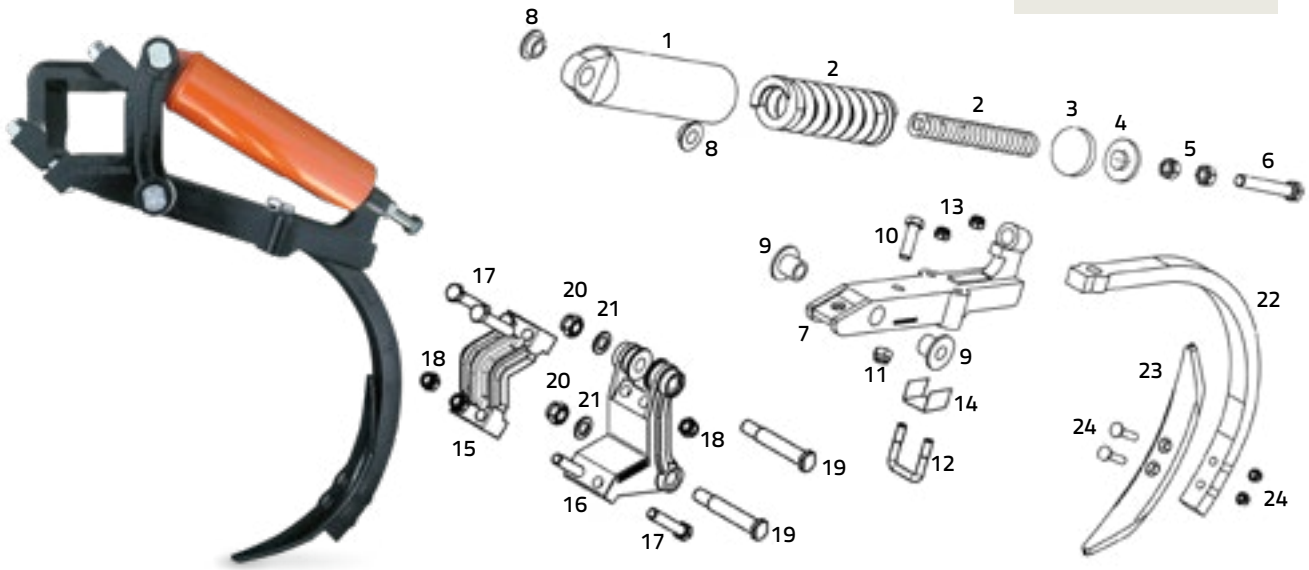











## Modelo CC404010

Cód. num. 1800225



Nº	Modelo	Código	Descripción	Características	KG
1		<b>1803603</b>	Tubo protector del muelle	40 x 40	3,10
2		<b>0802100</b>	Muelle exterior	390 x 90 x 20	8,20
2		<b>0800100</b>	Muelle interior	390 x 48 x 11	2,20
3		<b>1801801</b>	Tapa nylon sujeción muelle		0,10
4		<b>1805200</b>	Tapa metálica sujeción muelle	M. 24	0,15
5		<b>4554700</b>	Tuerca para tornillo regulación presión (x2)	D-934 M. 24	0,11
6		<b>4538700</b>	Tornillo regulación presión	D-933 8.8 M. 24 x 150	0,57
7		<b>1801600</b>	Caja chisel	40 x 40	13,50
8		<b>1802100</b>	Casquillo nylon superior (x2)		0,11
9		<b>1802200</b>	Casquillo nylon inferior (x2)		0,11
10		<b>4451000</b>	Tornillo amarre brazo	D-931 8.8 M. 24 x 80	0,38
11		<b>5007500</b>	Tuerca tornillo amarre brazo	D-985 M. 24	0,11

# DESPIECE CONJUNTOS CHISEL

Nº	Modelo	Código	Descripción	Características	KG
12		2402550	Abarcón brazo	8.8 14 x 50 x 75	0,20
13		5007000	Tuercas abarcón (x2)	D-985 M. 14	0,03
14		1802000	Chapa abarcón	40 x 40	0,14
15		1802501	Brida de amarre	40 x 40 CH 100 x 100	4,80
16		1801502	Cabeza chisel	40 x 40	11,70
17		4444200	Tornillo fijación brida-cabeza (x4)	D-931 8.8 M. 18 x 110	0,26
18		5007200	Tuerca tornillo fijación brida-cabeza (x4)	D-985 M. 18	0,05
19		3419200	Tornillo bulón (x2)	M. 22 x 150 10.9	0,55
20		5002400	Tuerca tornillo bulón (x2)	D-980 M. 22	0,08
21		2819300	Arandela plana tornillo bulón (x2)	D-125 M. 22	0,02
22		0404100	Brazo chisel 40 x 40 standar	40 x 40	11,00
23		0102000	Reja	37B - ES	2,15
24		3417100	Tuercas y tornillos reja (x2)	D-608 / 934 M. 12 x 70	0,08

## MODELOS ALTERNATIVOS / ALTERNATIVE MODELS / MODÈLES ALTERNATIFS

### CC404010L

Cód. num. 1800209









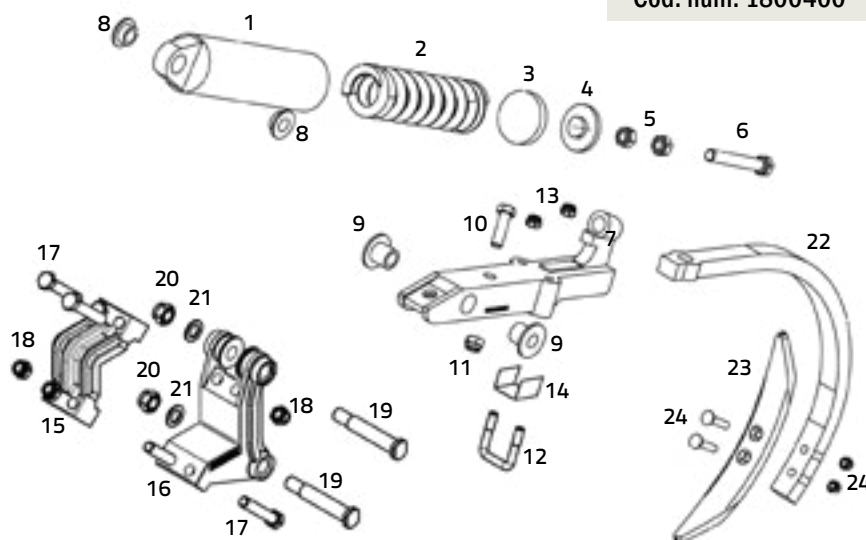





Nº	Pieza alternativa	Código	Descripción	Características	KG
22		0404200	Brazo chisel 40 x 40 alto	40 x 40	12,20

# DESPIECE CONJUNTOS CHISEL

## MODELO CC403010100

Cód. num. 1800400



Nº	Modelo	Código	Descripción	Características	KG
1		1803602	Tubo protector del muelle	40 x 30	3,00
2		0801600	Muelle exterior	300 x 90 x 18	5,10
3		1801802	Tapa nylon sujeción muelle		0,10
4		1805100	Tapa metálica sujeción muelle	M. 22	0,15
5		4554100	Tuerca para tornillo regulación presión (x2)	D-934 M. 22	0,08
6		4535700	Tornillo regulación presión	D-933 8.8 M. 22 x 150	0,47
7		1802400	Caja semichisel	40 x 30	7,50
8		1803100	Casquillo nylon superior (x2)		0,10
9		1803200	Casquillo nylon inferior (x2)		0,12
10		4443500	Tornillo amarre brazo	D-931 8.8 M. 18 x 70	0,18
11		5007200	Tuerca tornillo amarre brazo	D-985 M. 18	0,05
12		2402350	Abarcón brazo	8.8 14 x 50 x 65	0,19
13		5007000	Tuercas abarcón (x2)	D-985 M. 14	0,02
14		1802010	Chapa abarcón	40 x 30	0,20



# DESPIECE CONJUNTOS CHISEL

Nº	Modelo	Código	Descripción	Características	KG
15		1802501	Brida de amarre	40 x 30 CH 100 x 100	4,80
16		1802305	Cabeza chisel	40 x 30	7,10
17		4444200	Tornillo fijación brida-cabeza (x4)	D-931 8.8 M. 18 x 110	0,26
18		5007200	Tuerca tornillo fijación brida-cabeza (x4)	D-985 M. 18	0,05
19		3419200	Tornillo bulón (x2)	M. 22 x 150 10.9	0,55
20		5002400	Tuerca tornillo bulón (x2)	D-980 M. 22	0,08
21		2819300	Arandela plana tornillo bulón (x2)	D-125 M. 22	0,02
22		0403300	Brazo chisel	40 x 30	7,22
23		0102000	Reja	37B - ES	2,15
24		3416900	Tuercas y tornillos reja (x2)	D-608 / 934 M. 12 x 60	0,07

## MODELOS ALTERNATIVOS



### CC40301010L

Cód. num. 1800300

Nº	Pieza alternativa	Código	Descripción	Características	KG
22		0403400	Brazo chisel	40 x 30	8,25

### CC403080800

Cód. 1800500









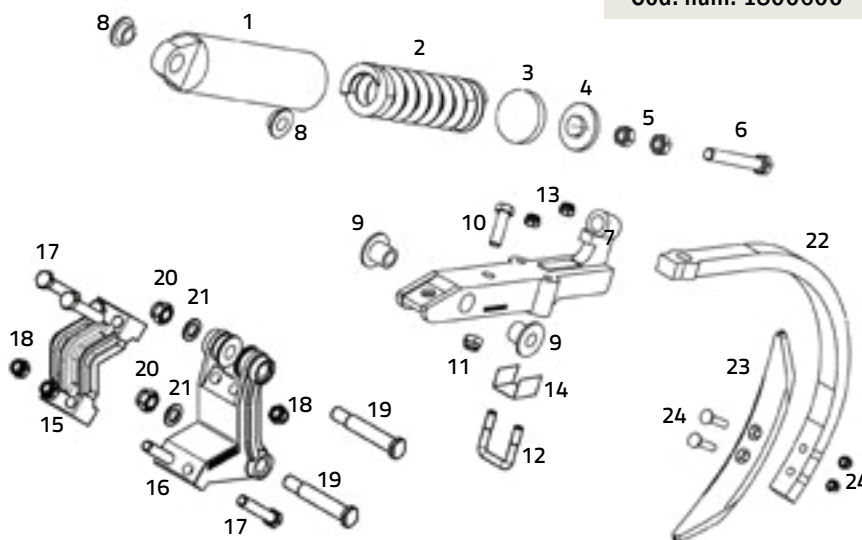

Nº	Pieza alternativa	Código	Descripción	Características	KG
16		1802601	Brida de amarre	40 x 30 CH 80 x 80	3,80
17		4443900	Tornillo fijación brida-cabeza (x4)	D-931 8.8 M. 18 x 90	0,22

# DESPIECE CONJUNTOS CHISEL











## Modelo CC353510100

Cód. num. 1800600



Nº	Modelo	Código	Descripción	Características	KG
1		1803602	Tubo protector del muelle	40 x 30	3,00
2		0801600	Muelle exterior	300 x 90 x 18	5,10
3		1801802	Tapa nylon sujeción muelle		0,10
4		1805100	Tapa metálica sujeción muelle	M. 22	0,15
5		4554100	Tuerca para tornillo regulación presión (x2)	D-934 M. 22	0,08
6		4535700	Tornillo regulación presión	D-933 8.8 M. 22 x 150	0,47
7		1802405	Caja semichisel	35 x 35	7,90
8		1803100	Casquillo nylon superior (x2)		0,10
9		1803200	Casquillo nylon inferior (x2)		0,12
10		4443500	Tornillo amarre brazo	D-931 8.8 M. 18 x 70	0,18
11		5007200	Tuerca tornillo amarre brazo	D-985 M. 18	0,05
12		2402350	Abarcón brazo	8.8 14 x 50 x 65	0,19
13		5007000	Tuercas abarcón (x2)	D-985 M. 14	0,03

# DESPIECE CONJUNTOS CHISEL

Nº	Modelo	Código	Descripción	Características	KG
14		1802800	Chapa abarcón	35 x 35	0,14
15		1802501	Brida de amarre	40 x 30 CH 100 x 100	4,80
16		1802305	Cabeza chisel	40 x 30	7,10
17		4444200	Tornillo fijación brida-cabeza (x4)	D-931 8.8 M. 18 x 110	0,26
18		5007200	Tuerca tornillo fijación brida-cabeza (x4)	D-985 M. 18	0,05
19		3419200	Tornillo bulón (x2)	M. 22 x 150 10.9	0,55
20		5002400	Tuerca tornillo bulón (x2)	D-980 M. 22	0,08
21		2819300	Arandela plana tornillo bulón (x2)	D-125 M. 22	0,02
22		0403200	Brazo chisel	35 x 35	7,00
23		0102000	Reja	37B - ES	2,15
24		3417000	Tuercas y tornillos reja (x2)	D-608 / 934 M. 12 x 65	0,08

## MODELOS ALTERNATIVOS

Bastidor 100 x 100	Modelo	Pieza alternativa	Código	Descripción	Características	KG
	<b>CC353510100V-D</b> Cód. num. 1800750	22 	<b>0413200</b>	Brazo chisel viñero	35 x 35 - VD	7,00
	<b>CC353510100V-I</b> Cód. num. 1800650	Dcho.  Izdo. 	<b>0413300</b>	Brazo chisel viñero	35 x 35 - VI	7,00







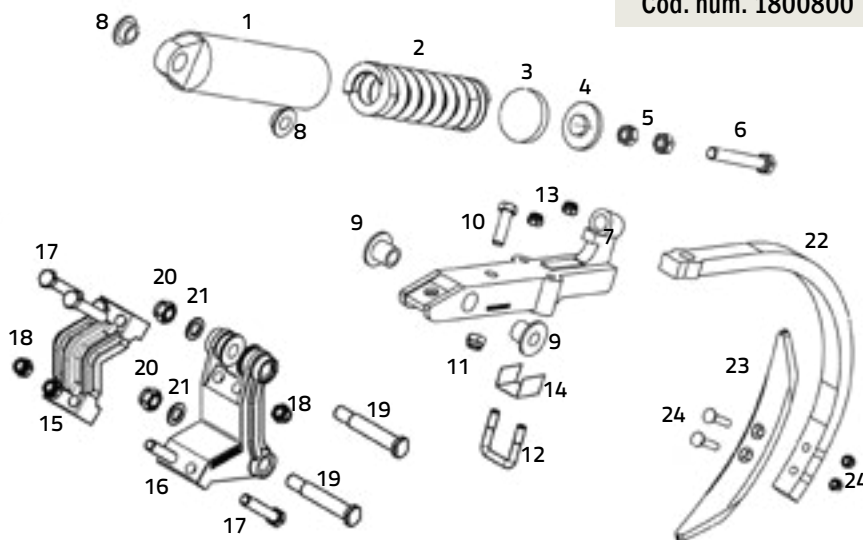

Bastidor 80 x 80	Modelo	Pieza alternativa	Código	Pieza alternativa	Código	Pieza alternativa	Código
	<b>CC353580800</b> Cód. num. 1800700	-	-	15 	<b>1802601</b> Brida de amarre 40 x 30 CH 80 x 80 3,80 Kg.	17 	<b>4443900</b> Tornillo fijación brida-cabeza (x4) D-931 8.8 M. 18 x 90 0,22 Kg.
	<b>CC353580800V-D</b> Cód. num. 1801750	22 Brazo chisel viñero 	<b>0413200</b> 35 x 35 7,00 Kg.				
<b>CC353580800V-I</b> Cód. num. 1801650	Dcho.  Izdo. 	<b>0413300</b> 35 x 35 7,00 Kg.					

# DESPIECE CONJUNTOS CHISEL











## Modelo CC30308080

Cód. num. 1800800



Nº	Modelo	Código	Descripción	Características	KG
1		1803601	Tubo protector del muelle	30 x 30	3,00
2		0800800	Muelle exterior	250 x 90 x 16	3,50
3		1801802	Tapa nylon sujeción muelle		0,10
4		1805100	Tapa metálica sujeción muelle	M. 22	0,15
5		4554100	Tuerca para tornillo regulación presión (x2)	D-934 M. 22	0,08
6		4535690	Tornillo regulación presión	D-933 8.8 M. 22 x 140	0,46
7		1802701	Caja chisel	30 x 30	7,00
8		1803100	Casquillo nylon superior (x2)		0,10
9		1803200	Casquillo nylon inferior (x2)		0,12
10		4440500	Tornillo amarre brazo	D-931 8.8 M. 16 x 60	0,12
11		5007100	Tuerca tornillo amarre brazo	D-985 M. 16	0,03
12		2402050	Abarcón brazo	8.8 M. 14 x 42 x 65	0,18
13		5007000	Tuercas abarcón (x2)	D-985 M. 14	0,03

# DESPIECE CONJUNTOS CHISEL







Nº	Modelo	Código	Descripción	Características	KG
14		<b>1802900</b>	Chapa abarcón	30 x 30	0,14
15		<b>1802601</b>	Brida de amarre	40 x 30 CH 80 x 80	3,80
16		<b>1802305</b>	Cabeza chisel	40 x 30	7,10
17		<b>4443900</b>	Tornillo fijación brida-cabeza (x4)	D-931 8.8 M. 18 x 90	0,22
18		<b>5007200</b>	Tuerca tornillo fijación brida-cabeza (x4)	D-985 M. 18	0,05
19		<b>3419200</b>	Tornillo bulón (x2)	M. 22 x 150 10.9	0,55
20		<b>5002400</b>	Tuerca tornillo bulón (x2)	D-980 M. 22	0,08
21		<b>2819300</b>	Arandela plana tornillo bulón (x2)	D-125 M. 22	0,02
22		<b>0402800</b>	Brazo chisel	30 x 30	5,50
23		<b>0102000</b>	Reja	37B - ES	2,15
24		<b>3416900</b>	Tuercas y tornillos reja (x2)	D-608 / 934 M. 12 x 60	0,07

## MODELOS ALTERNATIVOS

Modelo	Pieza alternativa	Código	Descripción	Características	KG
<b>CC30308080V-I</b> Cód. num. 1800901	22 	<b>0404400</b>	Brazo chisel viñero	30 x 30 - VI	6,00
<b>CC30308080V-D</b> Cód. num. 1800900		<b>0404300</b>	Brazo chisel viñero	30 x 30 VD	6,00

Modelo	Pieza alternativa	Código	Descripción	Características	KG
<b>CC323280800</b> Cód. num. 1801100	14 	<b>1803000</b>	Chapa abarcón	32 x 32	0,14
	22 	<b>0403000</b>	Brazo chisel	32 x 32	6,30

# TABLA DE EQUIVALENCIAS DE CONJUNTOS CHISEL

REJAS								Sin reja	Sin reja Sin brazo
CHISEL	0101901 R537BB00000	0102000 R537BESB000	0102100 R537BCNB000	0101700 R571B3AB000	0102200 R577B000000	0100800 R513A2CN8B0	0300106 RPW3606020R		
Chisel 40x40 Chasis 100x100	1800231	1800225	1800227	1800228	1800229	1800234	1800237	1800230	1800226
Chisel 40x40 "L" Chasis 100x100	1800210	1800209	1800211	1800212	1800214	1800215	1800216	1800213	1800226
Chisel 40x30 "L" Chasis 100x100	1800301	1800300	1800302	1800303		1800304	1800311	1800309	1800308
Chisel 40x30 Chasis 100x100	1800402	1800400	1800403	1800404		1800405	1800413	1800410	1800308
Chisel 40x30 Chasis 80x80	1800501	1800500	1800502	1800503		1800504	1800512	1800509	1800508
Chisel 35x35 Chasis 100x100	1800601	1800600	1800602	1800603		1800604	1800611	1800609	1800608
Chisel 35x35 "V" dcho. Chasis 100x100	1800751	1800750	1800752	1800753		1800754	1800755	1800759	1800608
Chisel 35x35 "V" izq. Chasis 100x100	1800651	1800650	1800652	1800653		1800654	1800655	1800659	1800608
Chisel 35x35 Chasis 80x80	1800702	1800700	1800703	1800704		1800705	1800712	1800710	1800709
Chisel 35x35 "V" dcho. Chasis 80x80	1801751	1801750	1801752	1801753		1801754	1801755	1801759	1800709
Chisel 35x35 "V" izq. Chasis 80x80	1801651	1801650	1801652	1801653		1801654	1801655	1801659	1800709

# TABLA DE EQUIVALENCIAS DE CONJUNTOS CHISEL

REJAS								Sin reja	Sin reja Sin brazo
CHISEL	0101901 R537BB00000	0102000 R537BESB000	0102100 R537BCNB000	0101700 R571B3AB000	0102200 R577B000000	0100800 R513A2CN8B0	0200400 R513ACN8F00		
Chisel 30x30 Chasis 80x80	1800804	1800800				1800806	1800812	1800811	1800810
Chisel 30x30 "V" lza. Chasis 80x80	1800920	1800901				1800923	1800928	1800927	1800810
Chisel 30x30 "V" dcho. Chasis 80x80	1800910	1800900				1800913	1800919	1800918	1800810
Chisel 30x30 Chasis 100 x 100	1801001	1801000				1801004	1801010	1801009	1801008
Chisel 30x30 "V" lza. Chasis 100 x 100	1800971	1800970				1800974	1800975	1800979	1801008
Chisel 30x30 "V" dcho. Chasis 100 x 100	1800951	1800950				1800954	1800955	1800959	1801008
Chisel 32x32 Chasis 80x80	1801102	1801100				1801105		1801110	1801109
Chisel 32x32 Chasis 100x100	1801151	1801150				1801154		1801159	1801158

## Tabla de equivalencias chisel de alto despeje

REJAS									Sin reja
CHISEL	0102100 R537BCNB000	0101700 R571B3AB000	0102200 R577B000000	0301200 R2808030SPW	0301300 RPWH2808030	0300106 RPW3606020R	0102600 RTWISTIB000	0102700 RTWISTDB000	
Alto despeje	1801415	1801416	1801414	1801427	1801428	1801419	1801426	1801427	1801413